

SHEER HORIZONTAL & VERTICAL SHADINGS

Shangri-La® Sheer Horizontal Shadings / Vertical Sheer Shadings / Soft Tones Sheer Shadings
Overtones™ Sheer Shades/ Paradises™ Sheer Shadings



**POWERTOUCHE™
RECHARGEABLE
MOTORIZED**
Option

2018

Manufacturer's Price List and Reference Guide | Effective April 1st

MDS Midwest
WINDOW FASHIONS Designer
Supply

www.midwestdesignersupply.com

888-523-2611
262-524-1007 (fax)



Comfortex
WINDOW FASHIONS

Comfortex Shangri-La® Sheer Horizontal Window Shadings, Soft Tones Sheer Shadings, Vertical Sheer Shadings, Paradise™ Sheer Shadings and Overtones™ Sheer Shades Price List and Reference Guide Effective April 1, 2018 - Updated April 18, 2018

This price list and reference guide contains product pricing, product specifications and technical information for the complete line of Comfortex Shangri-La Sheer Horizontal Shadings, Soft Tones Shadings, Vertical Sheer Shadings, Paradise Sheer Shadings and Overtones Sheer Shades.

Shangri-La Sheer Horizontal Shadings

Features At A Glance	5
Key Features	6-7
Hardware Upgrades and Surcharges	8
Fabric Collection Size Standards	9-11
Fabric Collections and Vane Sizes	12
Pricing Grids	13-17
2" Light Filtering	Price Group 1 13
2" Room Darkening	Price Group 2 13
2½" Light Filtering	Price Group 3 14
2½" Room Darkening	Price Group 4 14
3" Light Filtering	Price Group 5 15
3" Room Darkening	Price Group 6 15
2" DoorStyles Light Filtering	Price Group 7 16
2" DoorStyles Room Darkening	Price Group 8 16
3" DoorStyles Light Filtering	Price Group 9 17
3" DoorStyles Room Darkening	Price Group 10 17

Hardware

Cord Loop Designer Cassette Head Rail:	18-19
Cord Information for Shangri-La Shadings	19
Reverse Roll	19
Length Considerations with Shangri-La Shadings	19
Side by Side Alignment	19
Omni-View System	19
Retractable Cord	20
Two-On-One	21
Cordless	22-23
DoorStyles	24-25
PowerTouch Rechargeable	26-27
Simplicity Motorization	28-29
Simplicity Integrated Rechargeable	30-32
Solar Panel Recharge Option	32
Simplicity Smart Controller	33
Certified Fabrics	34
Flame Resistance	34
UV Protection	34
Vane Opening and Visibility	34
Vane Closure	34
Leveling Shangri-La Sheer Horizontals	34
Measuring Instructions for Shangri-La Sheer Horizontals	35
Skew Adjusting Bottom Rail	35
Cleaning and Care	35
Child Safety	94
Highlights Cornice Valance	36

Soft Tones Sheer Shadings

Features At A Glance	38
Key Features	39
Soft Tones Shadings Size Standards	39
5½" Light Filtering	Price Group 11 40

Hardware

Cord Loop Designer Cassette Head Rail:	41-42
Length Considerations	42
Soft Tones Shadings Operation	42
Fabric Positions	42
Side by Side Alignment	42
Soft Tones Shadings Cord Information	42
PowerTouch Rechargeable	43-44
Simplicity Motorization	45-46
Simplicity Integrated Rechargeable	47-49
Cleaning and Care	50
Measuring Instructions	94
Child Safety	94
Highlights Cornice Valance	36

Vertical Sheer Shadings

Features At A Glance	51
Vertical Sheer Size Standards	52
Panel Designs Finished Dimensions	52
3½" Light Filtering	Price Group 12 53
3½" Room Darkening	Price Group 13 53
Product Configurations	54
Vertical Sheer Shadings Fabric and Vanes	55
Tiltback	55
Vertical Sheer Shadings Hardware	56
Controls and Control Placement	56
Vertical Sheer Shadings Design and Operation	57
Vane Closure Gap	57
Split Stack Center Gap	58
Side by Side Abutted Applications	58
Abutted Gap	58
Return Gap	58
Measuring, Mounting Requirements and Installation Information	59-60
How to Avoid Common Ordering Errors	61
Stackback	62-63
UV Protection	64
Cleaning and Care	64
Child Safety	94

Paradise™ Sheer Shadings

Paradise Sheer Shadings Size Standards	66
Paradise Sheer Shading Features at a Glance	66
3½" Light Filtering	Price Group 14 67
3½" Light Filtering	Price Group 15 67
Paradise Cord Loop Sheer Shadings Hardware	68
Length Considerations with Paradise Sheer Shadings	69
Side By Side Alignment	69

Vane Opening And Closures	69
Paradise Sheer Shadings Operation	70
Shading Adjustment	70
UV Protection	70
Cleaning and Care	71
Paradise Sheer Shadings Detailed View	72
Paradise Cordless Sheer Shadings Hardware	73-74
Paradise PowerTouch Rechargeable	75-76
Simplicity Integrated Rechargeable	75-76
Measuring Instructions	93

Overtones™ Sheer Shades

Overtones Sheer Shades Fabric Specifications	81
Overtones Sheer Shades Size Standards	82
Overtones Sheer Shades Features at a Glance	82
3½" Light Filtering	Price Group 16 83
3½" Light Filtering	Price Group 17 83
3½" Light Filtering	Price Group 18 83
3½" Light Filtering	Price Group 19 84
3½" Light Filtering	Price Group 20 84
Overtones Cord Loop Sheer Shades Hardware	86
Cleaning and Care	86
Overtones Sheer Shades Operation	86
Overtones Sheer Shades Detailed View	87
PowerTouch Rechargeable	88-89
Simplicity Integrated Rechargeable	90-92
Measuring Instructions	93

Policy & Warranty

Measuring Instructions	93
Child Safety	94
Conditions of Sale	95
Policies	95
Motorized Shadings Warranty	95
Vertical & Horizontal Warranty Information	96
Limited Lifetime Warranty	96









Shangri-La® Sheer Horizontal Window Shadings

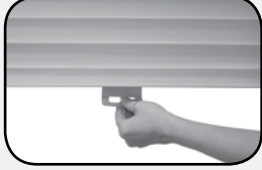

- Shangri-La is a window shading of unique beauty and performance for the finishing touch to a beautiful window and room.
- Horizontal fabric vanes float between two layers of soft, knitted fabric sheers to soften your view outside.
- Shangri-La is available to widths of 120" and drops to 132" to provide visual elegance to the widest of windows.
- Shangri-La is available in 2-inch, 2½-inch and 3-inch vane widths in both light filtering and room darkening fabrics.
- Shangri-La's 3-inch vane fabrics provide greater view through with our most popular colors.
- Vanes glide from open to closed to out of sight with elegant hardware.
- Choose from multiple hardware options to customize your shading: traditional cord loop, retractable cord, cordless, cordless PowerTouch with Touch and Go feature or Simplicity Integrated Rechargeable Motorization.
- Only the Omni-View cord system provides five distinctly different variations of vane position for numerous combinations of privacy, view and light control.
- Only with Shangri-La, can you partially raise the shading with the fabric vanes in the open, view-through position so you keep your view and still feel the outdoor breeze.
- A weight system in the bottom rail allows for on-the-spot skew adjustment for a balanced appearance in the window.
- The sophisticated array of Shangri-La colors is designed to flatter your decor.
- Create your customers own sophisticated look with the low light gap Designer Cassette Head Rail.
- A low side light gap provides minimal light leakage on shading sides and above the head rail for increased privacy.
- Easy to install hardware and brackets allow for effortless installations and easy removal for cleaning.
- Shangri-La Shadings may be ultrasonically or traditionally cleaned to stay bright and beautiful.
- A Limited Lifetime Warranty serves as a commitment to your satisfaction.



Sheer Horizontal Window Shadings Hardware Options

	Key Features	Color Options	Hardware Size (Depth x Height)	Shade Size Available	More Information
Cord Loop 	<ul style="list-style-type: none"> • Cord Loop makes operation easy • Smooth & quiet operation • Braided cord loop is used to raise and lower the shading • Bead Cord is optional 	<ul style="list-style-type: none"> • White • Ivory • Onyx Black • Oil Rubbed Bronze • Brushed Nickel 	Smooth Face: 3¾" x 2⅞" Fabric Insert: 3¾" x 2¾"	Width: 12" to 120"* Length: 12" to 132"***	Page 18
Retractable Cord 	<ul style="list-style-type: none"> • Single Cord Design • Provides easy one hand operation • Maintains a consistent length • Enhances child and pet safety 	<ul style="list-style-type: none"> • White • Black • Bronze 	Smooth Face: 3¾" to 2⅞" Fabric Insert: 3¾" to 2¾"	Width: 12" to 120"* Length: 12" to 132"***	Page 20
Cordless Shading 	<ul style="list-style-type: none"> • Cord Free • Roller catch mechanism in the head rail • Vanes easily adjusted into various positions 	<ul style="list-style-type: none"> • Clear handle • Bottom Rail is coordinated to the fabric (not matched to head rail) 	Smooth Face: 3¾" to 2⅞" Fabric Insert: 3¾" to 2¾"	Width: 20" to 84" Length: 18" to 96"	Page 22
Simplicity Motorization 	<ul style="list-style-type: none"> • Raise & lower shade with click of a button • Great for large and hard to reach windows • Remote can operate multiple shades 	<ul style="list-style-type: none"> • Designer Cassette options • 5 Channel Black or White Remote • 6 Channel white Remote with timer 	Smooth Face: 3¾" to 2⅞" Fabric Insert: 3¾" to 2¾"	Width: 14" to 120"* Length: 12" to 132"***	Page 28
Simplicity Rechargeable Motorization 	<ul style="list-style-type: none"> • Features a battery powered motor utilizing a rechargeable integrated battery pack • Raise & lower shading with click of a button • Great for large and hard to reach windows • Remote can operate multiple shades 	<ul style="list-style-type: none"> • Designer Cassette options • 5 Channel Black or White Remote • 6 Channel white Remote with timer 	Smooth Face: 3¾" to 2⅞" Fabric Insert: 3¾" to 2¾"	Width: 18" to 120"* Length: 12" to 132"***	Page 30
PowerTouch Rechargeable Cordless Wand 	<ul style="list-style-type: none"> • Raise & lower shading with push of a button • Eliminate the need to stand by the shading to operate; just touch and go • Favorite position button • Rechargeable battery with recharge port on pendant 	<ul style="list-style-type: none"> • Wand and pendant available in white or black 	Smooth Face: 3¾" x 2⅞" Fabric Insert: 3¾" x 2¾"	Width: 18" to 120" Length: 12" to 132"	Page 26

* Maximum width of 120" IB, 119¾" OB

** Light Filtering 132", Room Darkening 122"

Sheer Horizontal Window Shadings Hardware Options

	Key Features	Color Options	Hardware Size (Depth x Height)	Shade Size Available	More Information
Two on One Head Rail 	<ul style="list-style-type: none"> Operate two shades on one rail Great for larger windows Individually operating shades Available with Cord Loop, PowerTouch Rechargeable, Simplicity and Retractable Cord Not available with cordless 	<ul style="list-style-type: none"> White Ivory Onyx Black Oil Rubbed Bronze Brushed Nickel 	Smooth Face: 3¾" x 27/8" Fabric Insert: 3¾" x 2¾"	Individual Side Width: 12" to 102" Width: 24¾" to 140" Length: See Designer Cassette Specs	Page 21
DoorStyles 	<ul style="list-style-type: none"> Great option for narrow windows and doors Does not raise/lower, articulate vanes only No Pull cords Secure to door with hold down brackets 	<ul style="list-style-type: none"> Rails and end caps are coordinated to the fabric color 	2" to ½"	Width: 6" to 72" Length: 12" x 72"	Page 24
Highlights Cornice Valance 	<ul style="list-style-type: none"> Accenting Fabrics Adds height to windows Available as inside and outside mount Easy to install 	<ul style="list-style-type: none"> 100+ Envision fabrics 100s of PERSONA patterns and colors 	Width: 12" to 94" Height: 6" Returns: 1½" to 6"	Varies by selected fabric Width: 12" to 94"	Page 36

* Maximum length varies by width

Sheer Horizontal Shading Hardware Upgrade Options

LIFT SYSTEM	UPGRADES	ADD
Cord Loop	Bottom Up	Included
Retractable Cord	Bottom Up	\$99
Cordless Shading	Bottom Up	\$99

DESIGNER UPGRADE OPTIONS	UPGRADES	ADD
Add to Any Lift System Upgrade (Chart to the left)	Metallic Hardware	\$22
	Scotchgard Stain Protection	\$49
	Highlights Valance <i>See Page 36 For More Information</i>	

ADDITIONAL OPTIONS	UPGRADES	ADD
Add to Any Upgrade Above	Two-On-One Head Rail	Price as two shadings and add together.
Accessories	6 Foot Expandable Pole	\$65
	12 Foot Expandable Pole	\$79

Sheer Horizontal Shading **Motorized** Hardware Upgrade Options

MOTORIZED	UPGRADES	ADD	
PowerTouch Rechargeable Motorization System	Rechargeable Integrated Battery Pack	\$149	For More Information Page 26
	Plug-In Charger for Rechargeable Li-Ion	\$40	
Simplicity Motorization System	Motor and Battery Wand	\$439	For More Information Page 28
	Simplicity 5 Channel Remote	\$109	
	Simplicity 6 Channel Remote with Timer	\$175	
	48" Extension Wire	\$30	
	DC Power Supply/Transformer	\$112	
	7.4v Solar Panel & Mounting Brackets	\$95	
Simplicity Integrated Rechargeable Motorization System	Motor and Integrated Battery Pack	\$439	For More Information Page 30
	Simplicity 5 Channel Remote	\$109	
	Simplicity 6 Channel Remote with Timer	\$175	
	Plug-In Charger for Rechargeable Li-Ion	\$40	
	7.4v Solar Panel	\$95	
Simplicity Smart Controller System	NEO Controller	\$445	For More Information Page 33
	NEO Application for Mobile Devices	FREE	

TWO-ON-ONE PRICING EXAMPLE:

2" Light Filtering 42" x 60" Shadings:	\$1014.00 x 2
	\$2028.00
Retractable Cord Upgrade:	\$99 x 2
	\$198.00
Total List Price:	\$2226.00

SIMPLICITY RECHARGEABLE MOTORIZATION PRICING EXAMPLE:

2" Light Filtering 42" x 60" Shade:	\$1014.00
Metallic Hardware Option for Motorized Shades:	\$22.00
Simplicity Rechargeable Surcharge:	\$439.00
Charger for Rechargeable (required):	\$40.00
Simplicity Remote Control:	\$109.00

Total List Price: \$1624.00

Shangri-La® Sheer Horizontal Shading Fabric Collections Size Standards



		Cord Loop	Retractable Cord	Cordless Shading	Motorization
ALL FABRICS	Minimum Width	12"	12"	20"	14"
	Minimum Length	12"	12"	12"	12"

Light Filtering	Price Group	Page		Cord Loop	Retractable Cord	Cordless Shading	Motorization
2" Vanes	1	13	Maximum Width & Length	120"* x 132"	120"* x 132"	84" x 96"	120"* x 132"
2" Linen Vanes	1	13					
2½" Vanes	3	14					
3" Vanes	5	15					

Room Darkening	Price Group	Page		Cord Loop	Retractable Cord	Cordless Shading	Motorization
2" Vanes	2	13	Maximum Width & Length	120"* x 122"	120"* x 122"	84" x 96"	120"* x 122"
2" Linen Vanes	2	13					
2½" Vanes	4	14					
3" Vanes	6	15					

	Cord Loop	Retractable Cord	Cordless Shading	Motorization
More Information On Page	Page 18	Page 20	Page 22	Page 28

* Maximum width of 120" IB, 119¾" OB

Shangri-La® Sheer Horizontal Shading Fabric Collections Size Standards



		Motorization	Motorization	Two-On-One
		Simplicity Rechargeable	PowerTouch Rechargeable	
ALL FABRICS	Minimum Width	18"	18"	See Table Below ⁺
	Minimum Length	12"	12"	12"

				Motorization	Motorization	Two-On-One
				Simplicity Rechargeable	PowerTouch Rechargeable	
Light Filtering	Price Group	Page	Maximum Width & Length	120"* x 132"	120"* x 132"	140" x 132"
2" Vanes	1	13				
2" Linen Vanes	1	13				
2½" Vanes	3	14				
3" Vanes	5	15				

				Motorization	Motorization	Two-On-One
				Simplicity Rechargeable	PowerTouch Rechargeable	
Room Darkening	Price Group	Page #	Maximum Width & Length	120"* x 122"	120"* x 122"	140" x 122"
2" Vanes	2	13				
2" Linen Vanes	2	13				
2½" Vanes	4	14				
3" Vanes	6	15				

				Motorization	Motorization	Two-On-One
				Simplicity Rechargeable	PowerTouch Rechargeable	
More Information On Page				Page 30	Page 26	Page 21

* Maximum width of 120" IB, 119¾" OB

	Minimum Width	Hardware
TWO-ON-ONE HARDWARE ⁺	24"	Cord Loop
	24"	Retractable Cord
	NA	Cordless
	28"	Simplicity Motorization
	36"	Simplicity Rechargeable
	36"	PowerTouch Rechargeable

Shangri-La® DoorStyles Shading Size Standards



		DoorStyles
ALL FABRICS	Minimum Width	6"
	Minimum Length	12"

Light Filtering	Price Group	Page	DoorStyles	
2" Vanes	7	16	Maximum Width & Length	72" x 96"*
2" Linen Vanes	7	16		
2½" Vanes	NA	NA		
3" Vanes	9	17		

Room Darkening	Price Group	Page	DoorStyles	
2" Vanes	8	16	Maximum Width & Length	72" x 96"*
2" Linen Vanes	8	16		
2½" Vanes	NA	NA		
3" Vanes	10	17		

		DoorStyles
More Information On Page		Page 24

* Maximum length varies by width. Maximum length for doorstyles over 36" wide is 72".



Fabric Collections and Vane Sizes

Shangri-La Sheer Horizontal Window Shadings are available with different fabric collections.

COLLECTION	2" Vanes	2½" Vanes	3" Vanes
Light Filtering	•	•	•
Room Darkening	•	•	•
Linen Light Filtering	•	NA	NA

Please Note: Room Darkening fabrics are not blackout fabrics. Knitted fabric may experience minor weave variations due to heat, humidity and other room conditions. These variations can result in light bowing, puckering and dimpling of the Shangri-La material. This is considered normal and does not constitute a failure in either workmanship or materials. The possible variations are minor and have been shown through case study not to detract from the beauty of the product.

Product Options Availability

Use this table to ensure your coordinating options and unique shapes are consistent with your product selections.

CORD LOOP	2" Vanes	2" Linen Vanes	2½" Vanes	3" Vanes
Cord Loop	•	•	•	•
Cord Loop Two-On-One	•	•	•	•
RETRACTABLE CORD				
Retractable Cord	•	•	•	•
Retractable Cord Two-On-One	•	•	•	•
CORDLESS SHADING				
Cordless Shading	•	•	•	•
Cordless Shading Two-On-One	NA	NA	NA	NA
SIMPLICITY MOTORIZATION				
Simplicity Motorization	•	•	•	•
Simplicity Motorization Two-On-One	•	•	•	•
SIMPLICITY RECHARGEABLE MOTORIZATION				
Simplicity Rechargeable	•	•	•	•
Simplicity Rechargeable Two-On-One	•	•	•	•
POWERTOUCH RECHARGEABLE MOTORIZATION				
PowerTouch Rechargeable	•	•	•	•
PowerTouch Rechargeable Two-On-One	•	•	•	•
DOORSTYLE				
DoorStyle	•	•	NA	•



Smooth Face Designer Cassette



Fabric Insert Designer Cassette

2" Light Filtering Vanes

PRICE GROUP 1 Cord Loop

		Width In Inches												
		24	30	36	42	48	54	60	66	72	84	96	108	120
Length In Inches	36	585	655	734	802	879	954	1025	1101	1289	1447	1596	1938	2281
	42	616	694	772	857	938	1023	1101	1181	1376	1546	1706	2080	2454
	48	652	736	825	909	996	1085	1178	1270	1467	1644	1821	2228	2634
	54	679	771	866	962	1059	1154	1256	1362	1557	1742	1949	2439	2929
	60	710	815	913	1014	1115	1228	1334	1448	1638	1853	2076	2606	3136
	66	742	853	959	1068	1181	1299	1424	1539	1727	1970	2208	2772	3333
	72	772	890	1007	1122	1247	1376	1502	1630	1821	2080	2338	2953	3566
	78	795	921	1043	1172	1303	1438	1569	1707	1908	2187	2454	3101	3747
	84	828	959	1087	1233	1369	1511	1658	1802	2006	2304	2588	3258	3932
	90	863	996	1136	1287	1436	1594	1737	1890	2102	2414	2716	3437	4158
	96	894	1038	1184	1344	1502	1659	1815	1975	2200	2526	2845	3610	4373
	102	1026	1187	1352	1529	1690	1843	2060	2260	2418	2750	3067	3709	4468
	108	1081	1249	1424	1608	1774	1945	2165	2382	2548	2890	3230	3906	4581
114	1146	1325	1509	1706	1890	2066	2297	2525	2702	3067	3424	4144	4866	
120	1233	1420	1621	1827	2016	2208	2455	2702	2891	3285	3666	4435	5201	
126	1311	1511	1726	1946	2152	2354	2619	2885	3083	3502	3907	4727	5550	
132	1397	1610	1839	2072	2290	2512	2790	3073	3286	3732	4164	5039	5914	

2" Room Darkening Vanes

PRICE GROUP 2 Cord Loop

		Width In Inches												
		24	30	36	42	48	54	60	66	72	84	96	108	120
Length In Inches	36	644	721	807	882	967	1049	1128	1211	1418	1592	1756	2132	2509
	42	678	763	849	943	1032	1125	1211	1299	1514	1701	1877	2288	2699
	48	717	810	908	1000	1096	1194	1296	1397	1614	1808	2003	2451	2897
	54	747	848	953	1058	1165	1269	1382	1498	1713	1916	2144	2683	3222
	60	781	897	1004	1115	1227	1351	1467	1593	1802	2038	2284	2867	3450
	66	816	938	1055	1175	1299	1429	1566	1693	1900	2167	2429	3049	3666
	72	849	979	1108	1234	1372	1514	1652	1793	2003	2288	2572	3248	3923
	78	875	1013	1147	1289	1433	1582	1726	1878	2099	2406	2699	3411	4122
	84	911	1055	1196	1356	1506	1662	1824	1982	2207	2534	2847	3584	4325
	90	949	1096	1250	1416	1580	1753	1911	2079	2312	2655	2988	3781	4574
	96	983	1142	1302	1478	1652	1825	1997	2173	2420	2779	3130	3971	4810
	102	1129	1306	1487	1682	1859	2027	2266	2486	2660	3025	3374	4080	4915
	108	1189	1374	1566	1769	1951	2140	2382	2620	2803	3179	3553	4297	5039
114	1261	1458	1660	1877	2079	2273	2527	2778	2972	3374	3766	4558	5353	
120	1356	1562	1783	2010	2218	2429	2701	2972	3180	3614	4033	4879	5721	
122	1442	1662	1899	2141	2367	2589	2881	3174	3391	3852	4298	5200	6105	

LIFT SYSTEM	UPGRADES	ADD
Cord Loop	Bottom Up	Included
Retractable Cord	Bottom Up	\$99
Cordless Shading	Bottom Up	\$99

DESIGNER UPGRADE OPTIONS	UPGRADES	ADD
Add to Any Lift System Upgrade (Chart to the left)	Metallic Hardware	\$22
	Scotchgard Stain Protection	\$49
	Highlights Valance <i>See Page 36 For More Information</i>	

ADDITIONAL OPTIONS	UPGRADES	ADD
Add to Any Upgrade Above	Two-On-One Head Rail	Price as two shadings and add together.
Accessories	6 Foot Expandable Pole	\$65
	12 Foot Expandable Pole	\$79

MOTORIZATION	MORE INFO
For motorization surcharges and options refer to page 8.	Pg 8

Shadings wider than 96": Shadings over 96" in width may require additional fabrication and delivery time.

2 1/2" Light Filtering Vanes

PRICE GROUP 3 Cord Loop

		Width In Inches												
		24	30	36	42	48	54	60	66	72	84	96	108	120
Length In Inches	36	614	688	771	842	923	1002	1076	1156	1353	1519	1676	2035	2395
	42	647	729	811	900	985	1074	1156	1240	1445	1623	1791	2184	2577
	48	685	773	866	954	1046	1139	1237	1334	1540	1726	1912	2339	2766
	54	713	810	909	1010	1112	1212	1319	1430	1635	1829	2046	2561	3075
	60	746	856	959	1065	1171	1289	1401	1520	1720	1946	2180	2736	3293
	66	779	896	1007	1121	1240	1364	1495	1616	1813	2069	2318	2911	3500
	72	811	935	1057	1178	1309	1445	1577	1712	1912	2184	2455	3101	3744
	78	835	967	1095	1231	1368	1510	1647	1792	2003	2296	2577	3256	3934
	84	869	1007	1141	1295	1437	1587	1741	1892	2106	2419	2717	3421	4129
	90	906	1046	1193	1351	1508	1674	1824	1985	2207	2535	2852	3609	4366
	96	939	1090	1243	1411	1577	1742	1906	2074	2310	2652	2987	3791	4592
	102	1077	1246	1420	1605	1775	1935	2163	2373	2539	2888	3220	3894	4691
	108	1135	1311	1495	1688	1863	2042	2273	2501	2675	3035	3392	4101	4810
	114	1203	1391	1584	1791	1985	2169	2412	2651	2837	3220	3595	4351	5109
120	1295	1491	1702	1918	2117	2318	2578	2837	3036	3449	3849	4657	5461	
126	1377	1587	1812	2043	2260	2472	2750	3029	3237	3677	4102	4963	5828	
132	1467	1691	1931	2176	2405	2638	2930	3227	3450	3919	4372	5291	6210	

2 1/2" Room Darkening Vanes

PRICE GROUP 4 Cord Loop

		Width In Inches												
		24	30	36	42	48	54	60	66	72	84	96	108	120
Length In Inches	36	675	757	848	926	1015	1102	1184	1272	1488	1671	1844	2239	2635
	42	712	802	892	990	1084	1181	1272	1364	1590	1785	1970	2402	2835
	48	754	850	953	1049	1151	1253	1361	1467	1694	1899	2103	2573	3043
	54	784	891	1000	1111	1223	1333	1451	1573	1799	2012	2251	2817	3383
	60	821	942	1055	1172	1288	1418	1541	1672	1892	2141	2398	3010	3622
	66	857	986	1108	1233	1364	1500	1645	1778	1994	2276	2550	3202	3850
	72	892	1029	1163	1296	1440	1590	1735	1883	2103	2402	2701	3411	4118
	78	919	1064	1205	1354	1505	1661	1812	1971	2203	2526	2835	3582	4327
	84	956	1108	1255	1425	1581	1746	1915	2081	2317	2661	2989	3763	4542
	90	997	1151	1312	1486	1659	1841	2006	2184	2428	2789	3137	3970	4803
	96	1033	1199	1367	1552	1735	1916	2097	2281	2541	2917	3286	4170	5051
	102	1185	1371	1562	1766	1953	2129	2379	2610	2793	3177	3542	4283	5160
	108	1249	1442	1645	1857	2049	2246	2500	2751	2943	3339	3731	4511	5291
	114	1323	1530	1742	1970	2184	2386	2653	2916	3121	3542	3955	4786	5620
120	1425	1640	1872	2110	2329	2550	2836	3121	3340	3794	4234	5123	6007	
122	1515	1746	1993	2247	2486	2719	3025	3332	3561	4045	4512	5459	6411	

LIFT SYSTEM	UPGRADES	ADD
Cord Loop	Bottom Up	Included
Retractable Cord	Bottom Up	\$99
Cordless Shading	Bottom Up	\$99

DESIGNER UPGRADE OPTIONS	UPGRADES	ADD
Add to Any Lift System Upgrade (Chart to the left)	Metallic Hardware	\$22
	Scotchgard Stain Protection	\$49
	Highlights Valance <i>See Page 36 For More Information</i>	

ADDITIONAL OPTIONS	UPGRADES	ADD
Add to Any Upgrade Above	Two-On-One Head Rail	Price as two shadings and add together.
Accessories	6 Foot Expandable Pole	\$65
	12 Foot Expandable Pole	\$79

MOTORIZATION	MORE INFO
For motorization surcharges and options refer to page 8.	Pg 8

Shadings wider than 96": Shadings over 96" in width may require additional fabrication and delivery time.

3" Light Filtering Vanes

PRICE GROUP 5 Cord Loop

		Width In Inches												
		24	30	36	42	48	54	60	66	72	84	96	108	120
Length In Inches	36	644	721	807	882	967	1049	1128	1211	1418	1592	1756	2132	2509
	42	678	763	849	943	1032	1125	1211	1299	1514	1701	1877	2288	2699
	48	717	810	908	1000	1096	1194	1296	1397	1614	1808	2003	2451	2897
	54	747	848	953	1058	1165	1269	1382	1498	1713	1916	2144	2683	3222
	60	781	897	1004	1115	1227	1351	1467	1593	1802	2038	2284	2867	3450
	66	816	938	1055	1175	1299	1429	1566	1693	1900	2167	2429	3049	3666
	72	849	979	1108	1234	1372	1514	1652	1793	2003	2288	2572	3248	3923
	78	875	1013	1147	1289	1433	1582	1726	1878	2099	2406	2699	3411	4122
	84	911	1055	1196	1356	1506	1662	1824	1982	2207	2534	2847	3584	4325
	90	949	1096	1250	1416	1580	1753	1911	2079	2312	2655	2988	3781	4574
	96	983	1142	1302	1478	1652	1825	1997	2173	2420	2779	3130	3971	4810
	02	1129	1306	1487	1682	1859	2027	2266	2486	2660	3025	3374	4080	4915
	08	1189	1374	1566	1769	1951	2140	2382	2620	2803	3179	3553	4297	5039
	14	1261	1458	1660	1877	2079	2273	2527	2778	2972	3374	3766	4558	5353
20	1356	1562	1783	2010	2218	2429	2701	2972	3180	3614	4033	4879	5721	
26	1442	1662	1899	2141	2367	2589	2881	3174	3391	3852	4298	5200	6105	
32	1537	1771	2023	2279	2519	2763	3069	3380	3615	4105	4580	5543	6505	

3" Room Darkening Vanes

PRICE GROUP 6 Cord Loop

		Width In Inches												
		24	30	36	42	48	54	60	66	72	84	96	108	120
Length In Inches	36	708	793	888	970	1064	1154	1241	1332	1560	1751	1932	2345	2760
	42	746	839	934	1037	1135	1238	1332	1429	1665	1871	2065	2517	2969
	48	789	891	999	1100	1206	1313	1426	1537	1775	1989	2203	2696	3187
	54	822	933	1048	1164	1282	1396	1520	1648	1884	2108	2358	2951	3544
	60	859	987	1104	1227	1350	1486	1614	1752	1982	2242	2512	3154	3795
	66	898	1032	1161	1293	1429	1572	1723	1862	2090	2384	2672	3354	4033
	72	934	1077	1219	1357	1509	1665	1817	1972	2203	2517	2829	3573	4315
	78	963	1114	1262	1418	1576	1740	1899	2066	2309	2647	2969	3752	4534
	84	1002	1161	1316	1492	1657	1828	2006	2180	2428	2787	3132	3942	4758
	90	1044	1206	1375	1558	1738	1928	2102	2287	2543	2921	3287	4159	5031
	96	1081	1256	1432	1626	1817	2008	2197	2390	2662	3057	3443	4368	5291
	02	1242	1437	1636	1850	2045	2230	2493	2735	2926	3328	3711	4488	5407
	08	1308	1511	1723	1946	2146	2354	2620	2882	3083	3497	3908	4727	5543
	14	1387	1604	1826	2065	2287	2500	2780	3056	3269	3711	4143	5014	5888
20	1492	1718	1961	2211	2440	2672	2971	3269	3498	3975	4436	5367	6293	
22	1586	1828	2089	2355	2604	2848	3169	3491	3730	4237	4728	5720	6716	

LIFT SYSTEM	UPGRADES	ADD
Cord Loop	Bottom Up	Included
Retractable Cord	Bottom Up	\$99
Cordless Shading	Bottom Up	\$99

DESIGNER UPGRADE OPTIONS	UPGRADES	ADD
Add to Any Lift System Upgrade (Chart to the left)	Metallic Hardware	\$22
	Scotchgard Stain Protection	\$49
	Highlights Valance <i>See Page 36 For More Information</i>	

ADDITIONAL OPTIONS	UPGRADES	ADD
Add to Any Upgrade Above	Two-On-One Head Rail	Price as two shadings and add together.
Accessories	6 Foot Expandable Pole	\$65
	12 Foot Expandable Pole	\$79

MOTORIZATION	MORE INFO
For motorization surcharges and options refer to page 8.	Pg 8

Shadings wider than 96": Shadings over 96" in width may require additional fabrication and delivery time.

2" Light Filtering Vanes

PRICE GROUP 7
DoorStyles*

		Width In Inches											
		6	12	18	24	30	36	42	48	54	60	66	72
Length In Inches	12	496	507	521	532	593	668	717	732	812	828	846	1003
	18	497	513	526	542	609	685	742	757	842	864	883	1056
	24	499	519	534	553	620	705	761	783	877	897	921	1104
	30	503	523	544	562	634	720	785	809	909	935	958	1151
	36	506	526	552	585	655	734	802	879	954	1025	1101	1289
	42	542	569	594	616	694	772	857	938	1023	1101	1181	1376
	48	558	589	617	652	736	825	909	996	1085	1178	1270	1467
	54	572	607	642	679	771	866	962	1059	1154	1256	1362	1557
	60	590	627	664	710	815	913	1014	1115	1228	1334	1448	1638
	66	624	664	708	742	853	959	1068	1181	1299	1424	1539	1727
	72	642	687	734	772	890	1007	1122	1247	1376	1502	1630	1821
	78	655	709	757	795	921	1043						
84	679	732	785	828	959	1087							
90	696	755	814	863	996	1136							
96	717	779	841	894	1038	1184							

2" Room Darkening Vanes

PRICE GROUP 8
DoorStyles*

		Width In Inches											
		6	12	18	24	30	36	42	48	54	60	66	72
Length In Inches	12	546	558	573	585	652	735	789	805	893	911	931	1103
	18	547	564	579	596	670	754	816	833	926	950	971	1162
	24	549	571	587	608	682	776	837	861	965	987	1013	1214
	30	553	575	598	618	697	792	864	890	1000	1029	1054	1266
	36	557	579	607	644	721	807	882	967	1049	1128	1211	1418
	42	596	626	653	678	763	849	943	1032	1125	1211	1299	1514
	48	614	648	679	717	810	908	1000	1096	1194	1296	1397	1614
	54	629	668	706	747	848	953	1058	1165	1269	1382	1498	1713
	60	649	690	730	781	897	1004	1115	1227	1351	1467	1593	1802
	66	686	730	779	816	938	1055	1175	1299	1429	1566	1693	1900
	72	706	756	807	849	979	1108	1234	1372	1514	1652	1793	2003
	78	721	780	833	875	1013	1147						
84	747	805	864	911	1055	1196							
90	766	831	895	949	1096	1250							
96	789	857	925	983	1142	1302							

ADDITIONAL OPTIONS	
Scotchgard Stain Protection	\$49
Six Foot Operator Pole	\$65
Twelve Foot Operator Pole	\$79

*Rails and endcaps on Shangri-La DoorStyles Shadings are coordinated to the fabric color. Hardware used on DoorStyles may not match standard shadings.

3" Light Filtering Vanes

PRICE GROUP 9 DoorStyles*

		Width In Inches											
		6	12	18	24	30	36	42	48	54	60	66	72
Length In Inches	12	546	558	573	585	652	735	789	805	893	911	931	1103
	18	547	564	579	596	670	754	816	833	926	950	971	1162
	24	549	571	587	608	682	776	837	861	965	987	1013	1214
	30	553	575	598	618	697	792	864	890	1000	1029	1054	1266
	36	557	579	607	644	721	807	882	967	1049	1128	1211	1418
	42	596	626	653	678	763	849	943	1032	1125	1211	1299	1514
	48	614	648	679	717	810	908	1000	1096	1194	1296	1397	1614
	54	629	668	706	747	848	953	1058	1165	1269	1382	1498	1713
	60	649	690	730	781	897	1004	1115	1227	1351	1467	1593	1802
	66	686	730	779	816	938	1055	1175	1299	1429	1566	1693	1900
	72	706	756	807	849	979	1108	1234	1372	1514	1652	1793	2003
	78	721	780	833	875	1013	1147						
	84	747	805	864	911	1055	1196						
90	766	831	895	949	1096	1250							
96	789	857	925	983	1142	1302							

3" Room Darkening Vanes

PRICE GROUP 10 DoorStyles*

		Width In Inches											
		6	12	18	24	30	36	42	48	54	60	66	72
Length In Inches	12	601	614	630	644	717	809	868	886	982	1002	1024	1213
	18	602	620	637	656	737	829	898	916	1019	1045	1068	1278
	24	604	628	646	669	750	854	921	947	1062	1086	1114	1335
	30	608	633	658	680	767	871	950	979	1100	1132	1159	1393
	36	613	637	668	708	793	888	970	1064	1154	1241	1332	1560
	42	656	689	718	746	839	934	1037	1135	1238	1332	1429	1665
	48	675	713	747	789	891	999	1100	1206	1313	1426	1537	1775
	54	692	735	777	822	933	1048	1164	1282	1396	1520	1648	1884
	60	714	759	803	859	987	1104	1227	1350	1486	1614	1752	1982
	66	755	803	857	898	1032	1161	1293	1429	1572	1723	1862	2090
	72	777	832	888	934	1077	1219	1357	1509	1665	1817	1972	2203
	78	793	858	916	963	1114	1262						
	84	822	886	950	1002	1161	1316						
90	843	914	985	1044	1206	1375							
96	868	943	1018	1081	1256	1432							

ADDITIONAL OPTIONS	
Scotchgard Stain Protection	\$49
Six Foot Operator Pole	\$65
Twelve Foot Operator Pole	\$79

*Rails and endcaps on Shangri-La DoorStyles Shadings are coordinated to the fabric color.
Hardware used on DoorStyles may not match standard shadings.

Sheer Horizontal Shadings Head Rail Options

CORD LOOP | DESIGNER CASSETTE HEAD RAIL

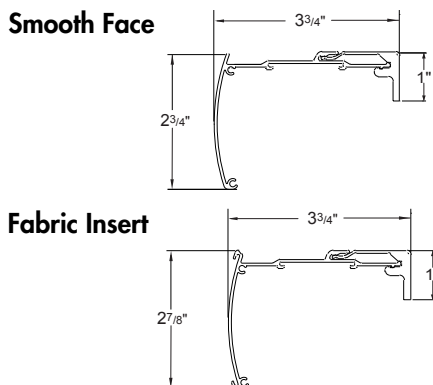

- Smooth Face Designer Cassette Head Rail**
- Depth of rail and bracket: 3 3/4"
 - Height of rail: 2 3/4"
 - Height of bracket: 1"

- Fabric Insert Designer Cassette Head Rail**
- Depth of rail and bracket: 3 3/4"
 - Height of rail: 2 7/8"
 - Height of bracket: 1"

Hardware Features	
Standard Designer Cassette	Choose from coordinating Fabric Insert or painted Smooth Face rail. Default head rail color is White or Ivory based on shading vane color.
Bottom Rail Color	Color coordinated rail with White/Ivory head rail. Bottom rail will be matched to Oil Rubbed Bronze or Onyx Black when metallic upgrade is selected.
Upgrades	
Designer Metallic Upgrade (Fabric Insert/Smooth Face)	<ul style="list-style-type: none"> • Oil Rubbed Bronze • Onyx Black • Brushed Nickel
Mounting Dimensions	
Designer Cassette Head Rail	
Minimum Shallow Mount	1"
Minimum Flush Inside Mount (including brackets)	3 3/4"
Minimum Outside Mount	1"
Minimum Side Mount	1 1/4"
Width Side Mount	48" Max width side mount
Finished Dimensions	
Inside Mount	
	<ul style="list-style-type: none"> • Fabric will measure ordered width less: 1" • Head rail* will measure ordered width less: 3/16"
Side (End) Mount	
	<ul style="list-style-type: none"> • Fabric will measure ordered width less: 1 1/2" • Head rail* will measure ordered width less: 1 1/16"
Outside Mount	
	<ul style="list-style-type: none"> • Fabric will measure ordered width less: 5/8" • Head rail* will measure ordered width plus: 3/16"
Exact (End Cap to End Cap) Mount	
	<ul style="list-style-type: none"> • Fabric will measure ordered width less: 13/16" • Head rail* will measure ordered width
* Head rail measurements include endcaps. Width and length measurements may vary +/- 1/8"	

Please Note: Once ordered and manufactured, the width of the Shangri-La fabric cannot be altered. Comfortex makes deductions to the width depending on the type of mounting indicated. For all mounting types, fabric will measure exactly the length ordered when the vanes are in the closed position.

Sheer Horizontal Shadings

DESIGNER CASSETTE HEAD RAIL HARDWARE SYSTEM | SPECIFICATIONS

Head Rail Inserts

Fabric head rail inserts are used on Designer Cassette Head Rail Shadings when specified.

We use the light filtering fabric insert strips on all shadings including room darkening colors. The color of the fabric insert coordinates with fabric used on the shading.

Cord Type and Color

White, black or bronze loop cord coordinates with your hardware choice. Bead cord is optional in white, bronze, black or steel. Cord tensioners match your hardware choice (white, black or bronze).

Reverse Roll

The braided cord does not have a reverse roll stop. If a shading with the Designer Cassette hardware is raised above 24" in the reverse roll mode, there is a possibility of the fabric rubbing on the head rail. Comfortex reserves the right NOT to warrant wear and tear of fabric if damaged by roll-up in excess of 24".

Length Considerations with Shangri-La Shadings

Comfortex will fabricate your Shangri-La Window Shading to the length ordered, when the vanes are in the closed position (Figure A).

- When the vanes are rotated to the open position, the shading will become slightly longer.
- When opened on an inside mount, the shading will be slightly longer than ordered length.
- A slight puckering may occur when the vanes are in the open position. Rotating the vanes closed will cause the bottom rail to touch the window sill, before it begins to raise.

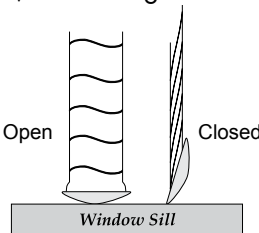

Figure A

Side By Side Alignment

When Shangri-La Window Shadings are installed side-by-side, vane alignment can be guaranteed within 1/4" only if:

- The shadings are the same color and ordered at the same time.
- The sum total of the widths of all shadings needing alignment is less than 118".

Side-by-side lineup is specified when the order is placed.

Omni-View System

Shangri-La Shadings feature the Omni-View™ Cord System. The Omni-View System provides the ability to manipulate the shading into various viewing positions. There are variations in visibility through the shadings when the vanes are tilted to their maximum open positions. The following five modes can be obtained with standard shading operation when viewing the shading at eye level.

- **Closed top, open bottom:** By partially lowering the shading from the fully raised position, the upper portion of your window will become semi-opaque while allowing a clear view below.
- **Fully private:** When lowered completely, Shangri-La provides complete privacy and softly diffused light.
- **Partially open:** Opening Shangri-La slightly will gradually increase the level of light and allow varying levels of view through.
- **View-through when lowered:** By completely opening the vanes, Shangri-La provides a softened, veiled view to the outside.
- **View-through when raised:** From the open or view-through position, continuing to pull down on the back of the cord will raise the fabric allowing a clear view outside from below, and a veiled view above. This exclusive feature allows Shangri-La to be raised up to 24" in this mode.
- Comfortex recommends that you **do not** raise the shading more than 24" off the sill in the view-through when raised mode. Refer to warranty section below for more information.
- Omni-View is only available with Shangri-La Shadings built with braided cord loop.

Cord Information For Shangri-La Shadings

A braided cord loop is used to raise and lower the shading. White, black or bronze loop cord matches your hardware choice. Cord tensioner will match the hardware color.

Bead cord is available in black, white, bronze, nickel and steel.

The cord loop will measure the length indicated below unless otherwise specified.

Shade Length	Standard Loop
16" to 26 ⁷ / ₈ "	1' (12")
27" to 39 ⁷ / ₈ "	2' (24")
40" to 59 ⁷ / ₈ "	3' (36")
60" to 83 ⁷ / ₈ "	4' (48")
84" to 107 ⁷ / ₈ "	5' (60")
108" and greater	6' (72")

Maximum cord length is 15 feet. Polyester cord can be ordered in custom lengths in 1 foot increments only.

Braided Cord Loop Warranty Information

The shadings built with a braided cord loop do not have a reverse roll stop. If a shading is raised above 24" in the reverse roll mode, there is a possibility of the fabric rubbing on the head rail. Comfortex reserves the right NOT to warrant wear and tear of fabric if damaged by roll-up in excess of 24".

Sheer Horizontal Shadings Head Rail Options

RETRACTABLE CORD | DESIGNER CASSETTE HEAD RAIL

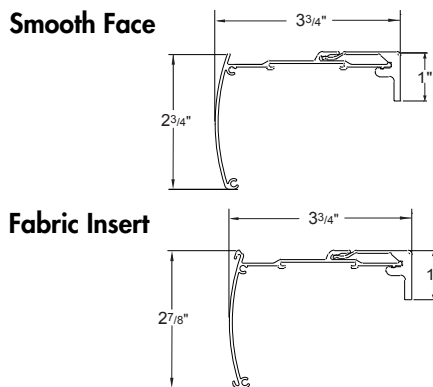

- Smooth Face Designer Cassette Head Rail**
- Depth of rail and bracket: 3 3/4"
 - Height of rail: 2 3/4"
 - Height of bracket: 1"
- Fabric Insert Designer Cassette Head Rail**
- Depth of rail and bracket: 3 3/4"
 - Height of rail: 2 7/8"
 - Height of bracket: 1"

Hardware Features	
Standard Designer Cassette	Choose from coordinating Fabric Insert or painted Smooth Face rail. Default head rail color is White or Ivory based on shading vane color.
Bottom Rail Color	Color coordinated rail with White/Ivory head rail. Bottom rail will be matched to Oil Rubbed Bronze or Onyx Black when metallic upgrade is selected.
Upgrades	
Designer Metallic Upgrade (Fabric Insert/Smooth Face)	<ul style="list-style-type: none"> • Oil Rubbed Bronze • Onyx Black
Mounting Dimensions	
Finished Dimensions	
Mounting and Finished Dimensions are the same as Cord Loop See Page 18	

Retractable Cord Shadings

The Retractable Cord option is a single cord design that provides easy one hand operation to raise, lower and open and close the vanes.

- Retractable Cord hardware is an alternative to conventional cord loop controls. The short retractable cord maintains a consistent length whether the shadings are raised or lowered. The elimination of cord loop enhances child and pet safety.
- Available with all fabrics with Designer Cassette.
- White, black or bronze cord and tassel coordinates your hardware color choice.
- Standard cord length is 2/3 the length of the shading. Cord may be shortened to match consumer operating preferences and to keep out of reach of children. Cord length can be easily modified in the field.
- Mounting a cord tensioner is not necessary.

Overall Operation

When raising and lowering the shading, pull the cord down in long, even strokes. Allow the cord to fully retract into the head rail after each downward stroke.

To Lower The Shading And Open The Vanes

- Pull the cord down toward the center of the shading with long strokes. Continue until the shading is fully lowered and the vanes are open.
- Allow the cord to retract completely into the head rail after each downward stroke.
- The shading can be stopped at any point while lowering

To Tilt The Vanes And Raise Shading

- Pull the cord straight down or down and slightly out with long strokes. With each stroke the shading partially raises.
- Allow the cord to retract completely into the head rail after each downward stroke.
- Use multiple strokes until the shading reaches the desired position.
- The shading can be stopped at any point while raising.

Sheer Horizontal Shadings Head Rail Options

TWO-ON-ONE | DESIGNER CASSETTE HEAD RAIL

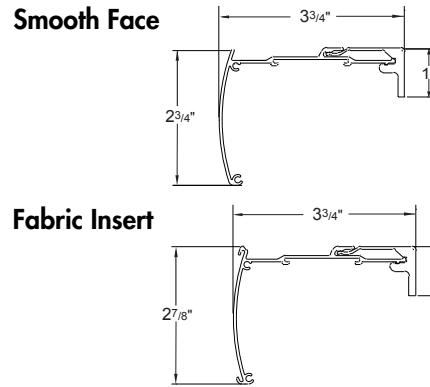

- Smooth Face Designer Cassette Head Rail**
- Depth of rail and bracket: 3 3/4"
 - Height of rail: 2 3/4"
 - Height of bracket: 1"

- Fabric Insert Designer Cassette Head Rail**
- Depth of rail and bracket: 3 3/4"
 - Height of rail: 2 7/8"
 - Height of bracket: 1"

Hardware Features	
Standard Designer Cassette	Choose from coordinating Fabric Insert or painted Smooth Face rail. Default head rail color is White or Ivory based on shading vane color.
Bottom Rail Color	Color coordinated rail with White/Ivory head rail. Bottom rail will be matched to Oil Rubbed Bronze or Onyx Black when metallic upgrade is selected.
Upgrades	
Designer Metallic Upgrade (Fabric Insert/Smooth Face)	<ul style="list-style-type: none"> • Oil Rubbed Bronze • Onyx Black • Brushed Nickel
Mounting Dimensions	
Finished Dimensions	
Mounting and Finished Dimensions are the same as Cord Loop See Page 18	

Two-On-One Designer Cassette Head Rail

Two-On-One Head Rail shadings are two shadings sharing the same head rail; each shading operates independently.

- Two-On-One Head Rail can be combined with cord loop, PowerTouch Rechargeable, Simplicity Motorization and retractable cord hardware options. Price as two shadings (including upgrades) and add together. Pricing example on page 6.
- Two-On-One not available with cordless.
- Specify shading total width and two individual section widths. **Note:** The two individual sections must add up to the total width.
- Two on One Head Rail Shadings are available with all vane sizes.
- Two on One Head Rail Shadings are available with bead cord or braided cord loop. See page 18 for more information.
- Controls will always be placed to the far left and far right.
- Available in widths up to 140" with Designer Cassette hardware.
- Minimum single section width is 12". Maximum single section width is 102". The center gap between shadings is 3/8".
- Side by side alignment is available if the two panels measure less than 120". Alignment must be specified when the order is placed.
- Shadings over 98" are subject to common carrier surcharge. See page 95 for more information on the freight policy.

Sheer Horizontal Shadings Head Rail Options

CORDLESS | DESIGNER CASSETTE HEAD RAIL

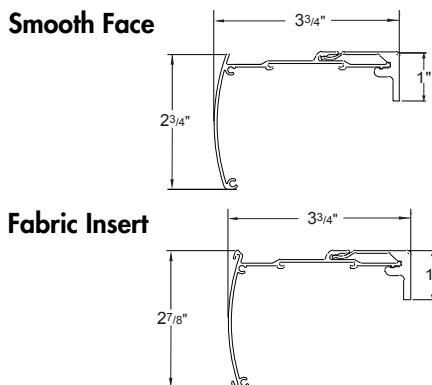

- Smooth Face Designer Cassette Head Rail**
- Depth of rail and bracket: 3 3/4"
 - Height of rail: 2 3/4"
 - Height of bracket: 1"

- Fabric Insert Designer Cassette Head Rail**
- Depth of rail and bracket: 3 3/4"
 - Height of rail: 2 7/8"
 - Height of bracket: 1"

Hardware Features	
Standard Designer Cassette	Choose from coordinating Fabric Insert or painted Smooth Face rail. Default head rail color is White or Ivory based on shading vane color.
Bottom Rail Color	Color coordinated rail with White/Ivory head rail. Bottom rail will be matched to Oil Rubbed Bronze or Onyx Black when metallic upgrade is selected. Hinged handle is clear.
Upgrades	
Designer Metallic Upgrade (Fabric Insert/Smooth Face)	<ul style="list-style-type: none"> • Oil Rubbed Bronze • Onyx Black • Brushed Nickel
Mounting Dimensions	
Designer Cassette Head Rail	
Minimum Shallow Mount	1"
Minimum Flush Inside Mount (including brackets)	3 3/4"
Minimum Outside Mount	1"
Minimum Side Mount	1 1/4"
Maximum Side Mount	48"
Finished Dimensions	
Inside Mount	
	<ul style="list-style-type: none"> • Fabric will measure ordered width less: 7/8" • Head rail* will measure ordered width less: 3/16"
Side (End) Mount	
	<ul style="list-style-type: none"> • Fabric will measure ordered width less: 1 3/8" • Head rail* will measure ordered width less: 1 1/16"
Outside Mount	
	<ul style="list-style-type: none"> • Fabric will measure ordered width less: 1/2" • Head rail* will measure ordered width plus: 3/16"
Exact (End Cap to End Cap) Mount	
	<ul style="list-style-type: none"> • Fabric will measure ordered width less: 1 1/16" • Head rail* will measure ordered width
* Head rail measurements include endcaps. Width and length measurements may vary +/- 1/8"	

Please Note: Once ordered and manufactured, the width of the Shangri-La fabric cannot be altered. Comfortex makes deductions to the width depending on the type of mounting indicated. For all mounting types, fabric will measure exactly the length ordered when the vanes are in the closed position.

Sheer Horizontal Shadings

CORDLESS | DESIGNER CASSETTE HEAD RAIL

Cordless Shangri-La Shadings Head Rail

- The Standard Designer Cassette head rail is with white or ivory aluminum with a coordinating fabric insert or Smooth Face.
- Designer Cassette head rail is also available in Oil Rubbed Bronze, Brushed Nickel and Onyx Black.
- Shangri-La Cordless Sheer Horizontal Shadings use quick-snap, no-light-gap brackets.

Cordless Shangri-La Shadings Bottom Rail

- Bottom rail includes sliding weight to adjust fabric skewing if necessary.
Please note: On Cordless Shangri-La Shadings the bottom rail is color coordinated to the fabric (not matched to the head rail). Hinged handle is clear.

Operating A Cordless Shangri-La Shading

Cordless Shangri-La Shadings utilize a roller catch mechanism in the head rail which allows for the vanes to be adjusted into various positions.

Operating The Shading

Pull the handle that is attached to the bottom rail until the shading reaches the desired length, allow catch mechanism to engage and lock shade in desired position.

To Open Or Close Vanes

Lower the shading all the way down and continue pulling down on the handle until the vanes open. The roller catch mechanism allows the vanes to be adjusted open, closed and to various positions in between.

When adjusting the vane position, release the catch by tugging on the handle, roll up the shading several inches (this resets the catch mechanism), then pull back down to the desired position.

- The Omni-View setting is not available with Shangri-La Cordless Shadings.

To Raise The Shading

Pull down on the handle to release the catch mechanism and let the shading rise. Tug the handle to lock the shade in the desired position.

When first learning to operate the shading, it may take a few tries to get the feel of the mechanism.



Cordless Handle

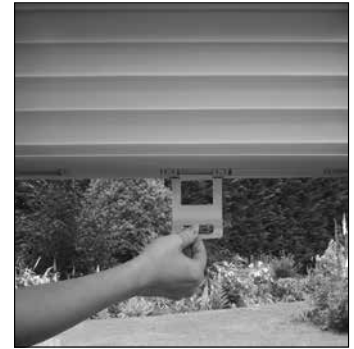

Cordless Handle Being Pulled Down



Cordless Handle on Window Sill

Sheer Horizontal Shadings Head Rail Options SHANGRI-LA DOORSTYLES

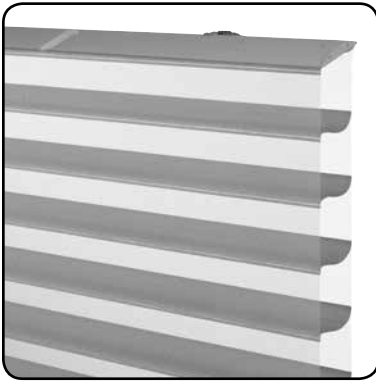

Hardware Features	
Standard Hardware	Hardware used on DoorStyles Shadings may not match standard shadings.
Bottom Rail Color	Rails and end caps on Shangri-la DoorStyles Shadings are coordinated to the fabric color.
Upgrades	
Designer Metallic Upgrade	DoorStyles Not Available
Mounting Dimensions	
DoorStyles Hardware	
Minimum Shallow Mount	1 1/2"
Minimum Flush Inside Mount (including brackets)	2 5/8"
Minimum Outside Mount	3/4"
Finished Dimensions	
Inside Mount	
	<ul style="list-style-type: none"> Fabric will measure ordered width less: 5/16" Head rail* will measure ordered width less: 3/16"
Outside Mount	
	<ul style="list-style-type: none"> Fabric will measure ordered width Head rail* will measure ordered width plus: 3/16"
Exact (End Cap to End Cap) Mount	
	<ul style="list-style-type: none"> Fabric will measure ordered width less: 3/16" Head rail* will measure ordered width
* Head rail measurements include endcaps. Width and length measurements may vary +/- 1/8" Side Mount is not available for DoorStyles	

Please Note: Once ordered and manufactured, the width of the Shangri-La fabric cannot be altered. Comfortex makes deductions to the width depending on the type of mounting indicated. For all mounting types, fabric will measure exactly the length ordered when the vanes are in the closed position.

Sheer Horizontal Shadings SHANGRI-LA DOORSTYLES

Shangri-La DoorStyles Shadings

Shangri-La DoorStyles Shadings cover French doors, transoms and sidelights for a look of sheer perfection without a bulky head rail. They attach to the window frame or door with unobtrusive hinges and tilt open and closed with easy to install hardware. An operating handle allows the fabric to be tilted open and closed (Figure A).

Hardware used on DoorStyle Shadings may not match standard shadings.

Fabric

All 2" and 3" light filtering and room darkening fabric collections are available as DoorStyle Window Shadings.

DoorStyles are **not** available with 2½" fabrics.

Rails and end caps on Shangri-La DoorStyles Shadings are coordinated to the fabric color.

Designer Metallic Hardware Upgrade: Not available with DoorStyles.

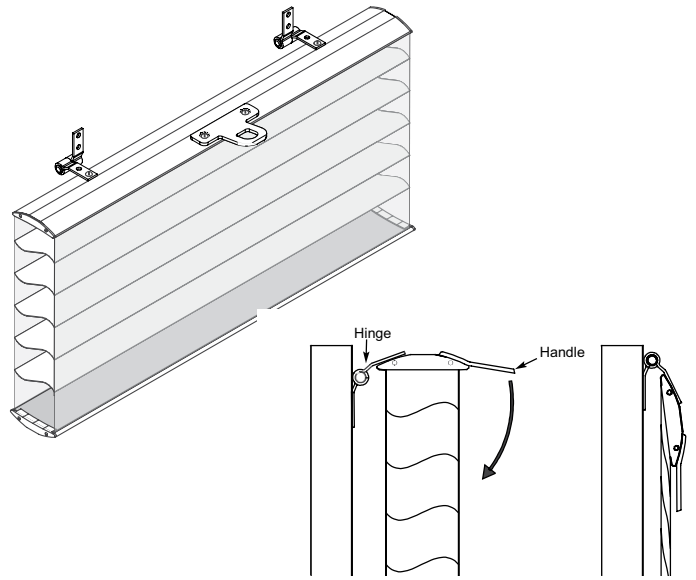
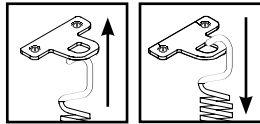

Figure A

Operating Pole

An operating pole is available for hard to reach windows and doors. Please specify when ordering.



6 Foot Expandable Pole: \$65.00

12 Foot Expandable Pole: \$79.00

DoorStyles Shading Specifications

Minimum Width: 6" Maximum Width: 72"

Minimum Length: 12" Maximum Length: 72"*

*Maximum length varies by width.

DoorStyles are **not** available with 2½" vane fabrics.

Please Note: Once ordered and manufactured, the width of the Shangri-La fabric cannot be altered. Comfortex makes deductions to the width depending on the type of mounting indicated. For all mounting types, fabric will measure exactly the length ordered when the vanes are in the open or "view-through" position.

Length Considerations With Shangri-La DoorStyles

Comfortex will fabricate your Shangri-La DoorStyles to the length ordered when the vanes are in the open (or view through) position. When the vanes are tilted to the closed position, the shading will become 1¾" longer.

When closed on an inside mount or when used with hold down brackets, a slight puckering may occur.

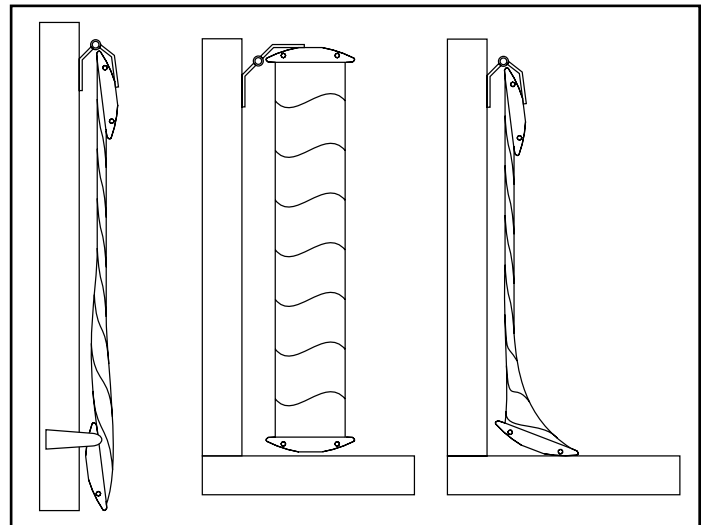

Sheer Horizontal Shadings Head Rail Options

POWERTOUCH RECHARGEABLE | DESIGNER CASSETTE HEAD RAIL

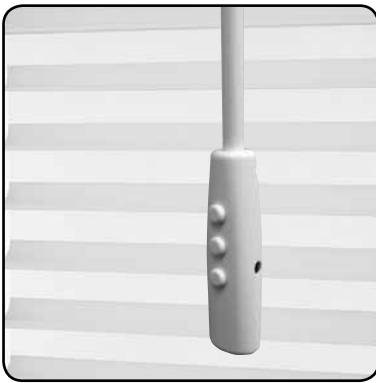

Smooth Face

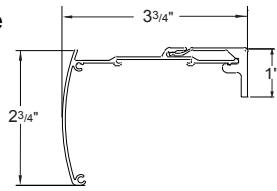

Smooth Face Designer Cassette Head Rail

- Depth of rail and bracket: 3 3/4"
- Height of rail: 2 3/4"
- Height of bracket: 1"

Fabric Insert

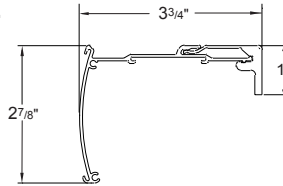

Fabric Insert Designer Cassette Head Rail

- Depth of rail and bracket: 3 3/4"
- Height of rail: 2 7/8"
- Height of bracket: 1"

Hardware Features	
Standard Designer Cassette	Choose from coordinating Fabric Insert or painted Smooth Face rail. Default head rail color is White or Ivory based on shading vane color.
Bottom Rail Color	Color coordinated rail with White/Ivory head rail. Bottom rail will be matched to Oil Rubbed Bronze or Onyx Black when metallic upgrade is selected.
Upgrades	
Designer Metallic Upgrade (Fabric Insert/Smooth Face)	<ul style="list-style-type: none"> • Oil Rubbed Bronze • Onyx Black • Brushed Nickel
Mounting Dimensions	
Designer Cassette Head Rail	
Minimum Shallow Mount	1"
Minimum Flush Inside Mount (including brackets)	3 3/4"
Minimum Outside Mount	1"
Minimum Side Mount	1 1/4"
Width Side Mount	48" Max width side mount
Finished Dimensions	
Inside Mount	
	<ul style="list-style-type: none"> • Fabric will measure ordered width less: 1" • Head rail* will measure ordered width less: 3/16"
Side (End) Mount	
	<ul style="list-style-type: none"> • Fabric will measure ordered width less: 1 1/2" • Head rail* will measure ordered width less: 11/16"
Outside Mount	
	<ul style="list-style-type: none"> • Fabric will measure ordered width less: 5/8" • Head rail* will measure ordered width plus: 3/16"
Exact (End Cap to End Cap) Mount	
	<ul style="list-style-type: none"> • Fabric will measure ordered width less: 13/16" • Head rail* will measure ordered width
* Head rail measurements include endcaps. Width and length measurements may vary +/- 1/8"	

Please Note: Once ordered and manufactured, the width of the Shangri-La fabric cannot be altered. Comfortex makes deductions to the width depending on the type of mounting indicated. For all mounting types, fabric will measure exactly the length ordered when the vanes are in the closed position.

Sheer Horizontal Shadings

POWERTOUCH RECHARGEABLE | DESIGNER CASSETTE HEAD RAIL

PowerTouch™ Rechargeable Shades

Sheer Shadings can be fabricated with the PowerTouch Rechargeable Push Button Control option. The PowerTouch Rechargeable option is an easy, cord free motorized operation for the budget savvy homeowner. PowerTouch Rechargeable uses Simplicity motors and components.

PowerTouch Rechargeable Shades Operation

Press the up or down button on the pendant to raise or lower the shading to your desired position. When the shading is fully lowered to the factory programmed lower limit, the bottom rail will be set in the level position.

No programming is required with PowerTouch™, all programming is set at the factory. Upper and lower limits easily can be adjusted in the field if desired. Please refer to the installation instructions at comfortex.com/comfortex-dealers. Favorites position can be programmed on-site.

PowerTouch Rechargeable Surcharges

See page 8.

PowerTouch Appearance

- The PowerTouch Rechargeable wand and pendant is attached to the head rail and requires no additional mounting.
- The wand and pendant hangs down the front of the shades from the head rail. The wand does not touch the fabric.
- Pendant is 2½" long.
- The pendant does not need to be mounted to the wall to operate the shade.



PowerTouch Rechargeable Color Options

- Shadings with Black or Oil Rubbed Bronze hardware will be built with black wand and pendants standard. All other colors will use white wand and pendants.



White



Black Shown with Plug-In Charger

PowerTouch Rechargeable Wand Length

The standard length of the wand will measure the indicated below unless otherwise specified.

Shading Length	Standard Wand Length
Up to 30"	1' (12")
>30" to 52"	2' (24")
>52" to 78"	3' (36")
>78" to 100"	4' (48")
>100" to 120"	5' (60")

- Wand length is in 1 foot increments. 1 foot - 5 foot

Mounting Requirements for PowerTouch Rechargeable Shadings

- No special installation hardware or wiring requirements are needed.
- The wand and pendant do not need to be mounted to operate the shading.

PowerTouch Rechargeable Battery Life

The battery life will vary based on the type of window covering selected, the size and weight of the window covering and the number of times you operate the blind on a daily basis.

Battery Charger

8.4 Volt charger requires a standard power outlet to recharge the battery. Must specify charger when ordering a Simplicity PowerTouch Rechargeable Shading. The charger plugs into the charger port. The charger is black and comes with a 156" wire. The dimensions are 1" wide x 2½" length x 1¾" deep.



PowerTouch Rechargeable Shadings Warranty

Please see page 95 for complete warranty information.

PowerTouch Wand and Pendant Location

The standard location for the wand and pendant is on the right. Please specify location when ordering.

Sheer Horizontal Shadings Head Rail Options

SIMPLICITY MOTORIZATION | DESIGNER CASSETTE HEAD RAIL

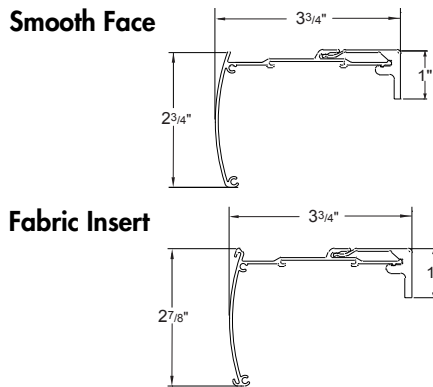

- Smooth Face Designer Cassette Head Rail**
- Depth of rail and bracket: 3 3/4"
 - Height of rail: 2 3/4"
 - Height of bracket: 1"

- Fabric Insert Designer Cassette Head Rail**
- Depth of rail and bracket: 3 3/4"
 - Height of rail: 2 7/8"
 - Height of bracket: 1"

Hardware Features	
Standard Designer Cassette	Choose from coordinating Fabric Insert or painted Smooth Face rail. Default head rail color is White or Ivory based on shading vane color.
Bottom Rail Color	Color coordinated rail with White/Ivory head rail. Bottom rail will be matched to Oil Rubbed Bronze or Onyx Black when metallic upgrade is selected.
Upgrades	
Designer Metallic Upgrade (Fabric Insert/Smooth Face)	<ul style="list-style-type: none"> • Oil Rubbed Bronze • Onyx Black • Brushed Nickel
Mounting Dimensions	
Designer Cassette Head Rail	
Minimum Shallow Mount	1"
Minimum Flush Inside Mount (including brackets)	3 3/4"
Minimum Outside Mount	1"
Minimum Side Mount	1 1/4"
Width Side Mount	48" Max width side mount
Finished Dimensions	
Inside Mount	
	<ul style="list-style-type: none"> • Fabric will measure ordered width less: 1" • Head rail* will measure ordered width less: 3/16"
Side (End) Mount	
	<ul style="list-style-type: none"> • Fabric will measure ordered width less: 1 1/2" • Head rail* will measure ordered width less: 11/16"
Outside Mount	
	<ul style="list-style-type: none"> • Fabric will measure ordered width less: 5/8" • Head rail* will measure ordered width plus: 3/16"
Exact (End Cap to End Cap) Mount	
	<ul style="list-style-type: none"> • Fabric will measure ordered width less: 13/16" • Head rail* will measure ordered width
* Head rail measurements include endcaps. Width and length measurements may vary +/- 1/8"	

Please Note: Once ordered and manufactured, the width of the Shangri-La fabric cannot be altered. Comfortex makes deductions to the width depending on the type of mounting indicated. For all mounting types, fabric will measure exactly the length ordered when the vanes are in the closed position.

Sheer Horizontal Shadings

SIMPLICITY MOTORIZATION | DESIGNER CASSETTE HEAD RAIL

Simplicity Motors

The Simplicity Motor program features a battery powered motor utilizing a single battery wand or plug-in DC transformer. Simplicity motors are compact and use a radio frequency remote to raise or lower the shadings. The Simplicity motor is concealed in the head rail.

See page 30 for information on Simplicity Rechargeable system version.

Simplicity Motors With Designer Cassette

No special installation hardware or wiring requirements are needed to install motorized Shangri-La Shadings with Designer Cassette Head Rail. See page 28 for mounting information.

Simplicity Battery Wand

The battery wand can be clipped to the Designer Cassette head rail. Can not be mounted on shadings under 25" wide. The battery wand is wall or ceiling mounted utilizing white battery wand clips. The 12 volt battery wand measures 17¼", and comes with eight alkaline batteries, and is white in color. The battery wand must be placed so it does not interfere with the mounting brackets.

The battery wire is 10" long. A 48" extension wire is available.



Simplicity Motor Battery Life and Replacement

Eight alkaline batteries are included with the wand. The battery life will vary based on the type of window covering selected, the size and weight of the window covering and the number of times you operate the shade on a daily basis.

Comfortex will warranty batteries for up to 3 months from date of purchase. Batteries are not covered by the warranty.

DC Power Supply/Transformer

12 Volt DC power supply/transformer is available and requires a standard power outlet to power the motor. The transformer is an alternative to a battery wand. Each transformer can power a single shading. The power supply must plug in to the motor. The DC power supply is white and comes with a 80" wire. The dimensions are 1⅞" wide x 3¼" long x 1¼" deep. Extension wires are available if needed.



Important Simplicity Motorized Shading Operating and Installation Information

Simplicity Motorized Shadings installed into windows with metal casings may have a reduced radio frequency range, or may not operate at all, depending on the application

Simplicity Motor Hand Held Remotes 5 Channel Remote

The **5 Channel (5C) remote** can operate up to five shadings simultaneously, individually or in groups. **WHEN ORDERING PLEASE SPECIFY WHICH CHANNELS ARE ASSIGNED TO EACH SHADING OR GROUP OF SHADINGS.**

For example; program line 1 to channel 1, line 2 and 3 to channel 2, etc. If no channels are assigned at time of order, all shadings will be programmed to Channel 1.

Simplicity (5C) remotes and holders are black or white in color. The remote comes with a holder which can be mounted to a wall for easy storage. The range of the remote is approximately 80 feet.



6 Channel Timer Remote

The **6 Channel (6C) timer remote** combines the functionality of a six channel hand-held control with the convenience of a programmable timer.

- The 6C timer remote allows for 18 different scheduled actions.
- Manual function disables the timer and the remote then operates as a hand held remote.

Simplicity (6C) remotes and holders are available in white. The remote comes with a holder which can be mounted to a wall for easy storage. The range of the remote is approximately 80 feet.



WHEN ORDERING PLEASE SPECIFY WHICH CHANNELS ARE ASSIGNED TO EACH SHADING OR GROUP OF SHADINGS.

For example; program line 1 to channel 1, line 2 and 3 to channel 2, etc. If no channels are assigned at time of order, all shadings will be programmed to Channel 1.

Simplicity Battery Operated Motorized Shadings Warranty

Please see page 95 for complete Comfortex warranty information.

Sheer Horizontal Shadings Head Rail Options

SIMPLICITY INTEGRATED RECHARGEABLE MOTORIZATION HEAD RAIL

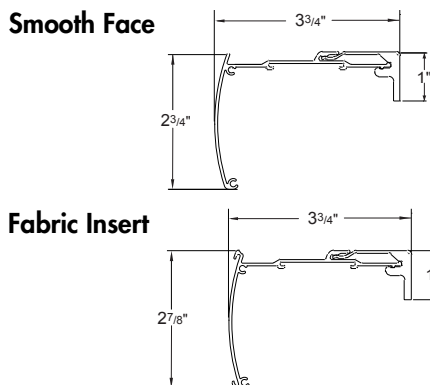

- Smooth Face Designer Cassette Head Rail**
- Depth of rail and bracket: 3 3/4"
 - Height of rail: 2 3/4"
 - Height of bracket: 1"

- Fabric Insert Designer Cassette Head Rail**
- Depth of rail and bracket: 3 3/4"
 - Height of rail: 2 7/8"
 - Height of bracket: 1"

Hardware Features	
Standard Designer Cassette	Choose from coordinating Fabric Insert or painted Smooth Face rail. Default head rail color is White or Ivory based on shading vane color.
Bottom Rail Color	Color coordinated rail with White/Ivory head rail. Bottom rail will be matched to Oil Rubbed Bronze or Onyx Black when metallic upgrade is selected.
Upgrades	
Designer Metallic Upgrade (Fabric Insert/Smooth Face)	<ul style="list-style-type: none"> • Oil Rubbed Bronze • Onyx Black • Brushed Nickel
Mounting Dimensions	
Designer Cassette Head Rail	
Minimum Shallow Mount	1"
Minimum Flush Inside Mount (including brackets)	3 3/4"
Minimum Outside Mount	1"
Minimum Side Mount	1 1/4"
Width Side Mount	48" Max width side mount
Finished Dimensions	
Inside Mount	
	<ul style="list-style-type: none"> • Fabric will measure ordered width less: 1" • Head rail* will measure ordered width less: 3/16"
Side (End) Mount	
	<ul style="list-style-type: none"> • Fabric will measure ordered width less: 1 1/2" • Head rail* will measure ordered width less: 11/16"
Outside Mount	
	<ul style="list-style-type: none"> • Fabric will measure ordered width less: 5/8" • Head rail* will measure ordered width plus: 3/16"
Exact (End Cap to End Cap) Mount	
	<ul style="list-style-type: none"> • Fabric will measure ordered width less: 13/16" • Head rail* will measure ordered width
* Head rail measurements include endcaps. Width and length measurements may vary +/- 1/8"	

Please Note: Once ordered and manufactured, the width of the Shangri-La fabric cannot be altered. Comfortex makes deductions to the width depending on the type of mounting indicated. For all mounting types, fabric will measure exactly the length ordered when the vanes are in the closed position.

Sheer Horizontal Shadings

SIMPLICITY INTEGRATED RECHARGEABLE MOTORIZATION HEAD RAIL

Simplicity Rechargeable Motors

The Rechargeable Simplicity Motor program features an integrated rechargeable lithium ion battery in the motor casing and is fully concealed by the roller tube.

PowerTouch Integrated Rechargeable Surcharges

See page 10 for shading standards and page 8 for surcharges and pricing example.

Simplicity Rechargeable Motors

No special installation hardware or wiring requirements are needed to install motorized Shangri-La Shadings with Designer Cassette Head Rail. No external battery wand is required. See page 30 for mounting information.

Rechargeable Simplicity Motor Batteries

The battery for the integrated rechargeable simplicity motor system is integrated within the motor casing and is fully concealed by the roller tube.

Rechargeable battery comes fully charged from the factory.

Integrated Rechargeable Motor Battery Life

Rechargeable battery is included with the motor.

The average battery charge will last 6-12 months based on an average sized shade raised and lowered once per day. The life of the battery charge will vary based on the type of window covering selected, the size and weight of the window covering and the number of times the shade is operated on a daily basis.

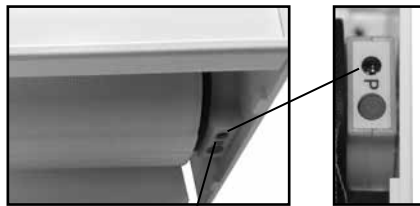

Charging Port

Close-Up

The battery can be recharged up to 500 times. It takes approximately 5 hours to recharge the motor when fully depleted.

Integrated Rechargeable Motor Battery Charger

An 8.4 Volt charger requires a standard power outlet to recharge the battery. The charger must be specified when ordering an Integrated Rechargeable Simplicity Motorized shade. The charger plugs into the charging port of the motor. Required with Integrated Shading order. Sold separately.



The charger is black and comes with a 156" wire. The dimensions are 1" wide x 2½" length x 1¾" deep.

Simplicity Motor Hand Held Remotes

IMPORTANT: Simplicity Rechargeable Motorized Shadings are programmed at the factory with the "up and down" limits. The shades are **UNLINKED** from the remote so they are not able to operate during shipping. Each shade should be installed **before** linking it to the remote.

5 Channel Remote

The **5 Channel (5C) remote** can operate up to five shadings simultaneously, individually or in groups.

Simplicity (5C) remotes and holders are black or white in color. The remote comes with a holder which can be mounted to a wall for easy storage. The range of the remote is approximately 80 feet.



6 Channel Timer Remote

The **6 Channel (6C) timer remote** combines the functionality of a six channel hand-held control with the convenience of a programmable timer.

- The 6C timer remote allows for 18 different scheduled actions.
- Manual function disables the timer and the remote then operates as a hand held remote.



Simplicity (6C) remotes and holders are available in white. The remote comes with a holder which can be mounted to a wall for easy storage. The range of the remote is approximately 80 feet.

Please Note:

- Not all motors run at the same rate of speed.
- Simplicity motors have a "Favorites" or "MY" position setting. If the homeowner wants to set several shadings at the same intermediate position, follow instructions provided with installation manual.
- **WHEN ORDERING THE NEW INTEGRATED RECHARGEABLE, PLEASE ORDER THE NECESSARY BATTERY CHARGER.**

Solar Panel Recharge Option

Plugs in to any Simplicity Rechargeable Remote control shade (does not work with PowerTouch). See page 32.



Dimensions of panel
18½" x 1½"

Sheer Horizontal Shadings

SIMPLICITY INTEGRATED RECHARGEABLE MOTORIZATION HEAD RAIL

Important Information about Integrated Rechargeable Simplicity Motor Shading Operation and Installation

- Simplicity Motorized Shadings installed into windows with metal casings may have a reduced radio frequency range, or may not operate at all, depending on control.
- Be mindful of when your shade starts to slow down during operation. It is a good indicator the shade needs to be recharged.

Retrofit Existing Standard Simplicity Motorized Shadings with Rechargeable Batteries

Sheer shadings made with Standard Simplicity Motorization can be retrofitted with the NEW Rechargeable Simplicity Motorization External Battery Wand. The Rechargeable battery wand is 22" long, comes with 10 NiMH batteries, and is white in color. Battery wands are charged at the factory.

To retrofit the rechargeable battery wand to an existing shading with a cassette head rail, you must have at least 24" between bracket centerlines to fit the battery wand. Otherwise, the wand must be placed elsewhere along the window. Wall mounting clips are provided with the wand.

Retrofit Ordering Requirements:

- Rechargeable battery wand with clips (one per shade)
- Rechargeable battery charger (one or more per order, or as needed)
- Charging port mounting base (optional)

Please contact customer service for more information.



Battery Wand for Rechargeable Simplicity

Simplicity Battery Operated Motorized Shadings Warranty

Please see page 95 for complete Comfortex warranty information.

Solar Panel Recharge Option

Plugs in to any Simplicity Rechargeable Remote control shade (does not work with PowerTouch)

Provides constant trickle charge to 7.4v Li-ION Rechargeable battery packs. Does not require direct sunlight, but performs best in regular direct sunlight applications. Will prolong the life of the charge of the 7.4v rechargeable battery packs, and in some applications will maintain charge indefinitely.

Life of charge is subject to application variables such as, size and weight of shade, frequency of use, amount of direct sunlight exposure, etc.



Dimensions of panel
18½" x 1½"



Sheer Shadings Motorization Option SIMPLICITY SMART CONTROLLER

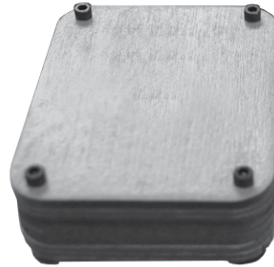

Simplicity Smart Controller Dimensions

- Width of controller: 2³/₈"
- Length of controller: 2¹/₁₆"
- Height of controller: 1¹/₈"

Simplicity Smart Controller

- Works with Apple and Android devices
- FREE Downloadable Application
- Compatible with previously installed Simplicity Remote Controlled Shades
- Powered by NEO Smart Blinds App.

Simplicity Smart Controller

The Simplicity Smart Controller is a small device that you install in your home that allows you to set automatic opening and closing times for all Simplicity motorized shades as well as the ability to control your motorized shades from a phone, tablet or PC anywhere in world.

The Simplicity Smart Controller will work with any Comfortex motorized shade with Simplicity Remote Controlled motors purchased after 2012.

The Simplicity Smart Controller plugs into a standard electrical outlet and connects to WiFi and sends signals to your shades using the same radio frequencies as a normal remote control.

How Does The NEO Smart Blinds App Work?

The app uses WiFi or cellular data to send commands over the internet to the Simplicity Smart Controller.

Do I Need Any Other Equipment?

Yes, The location where your shades are installed must have WiFi in order for the Simplicity Smart Controller to work. Additionally, you must have a smartphone or tablet running Android or iOS (eg. iPhone, iPad, Samsung Galaxy S7) and have the NEO Smart Blinds app. installed.

Why Would I Want A Simplicity Smart Controller?

There are 2 main ways the Simplicity Smart Controller adds additional value to your motorized shades. First, once all of your shades have been added you can use your smartphone as a single remote for all of your shades. It will work anywhere you are regardless of distance from the shade. Secondly, the device allows you to set schedules so your motorized shades automatically open and close without needing to do anything on a day to day basis.

Do I Need To Buy More Than 1 Controller?

The normal use for the Simplicity Smart Controller is to plug it in out of the way and forget it. Since it has roughly the same range as a remote you will want enough devices to allow all shades to be operated without moving the controller. So depending on the layout of the home and location of the shade, you might want multiple devices to have convenient full home coverage.

How Far Is The Range Of A Controller?

You should see a range of approximately 150 ft. However this number might be less depending on the layout of your home. In general we recommend one per a floor of a normal sized home.

Can I Control My Shades From Multiple Devices?

Yes! You can download the NEO Smart Blinds app onto multiple devices, After installing the app on a new device simply log in with the same email/password on each device and you will have access to control your shades.

Can It Be Used With Already Installed Shades?

Yes! Simply follow the directions in the NEO Smart Blinds app to add a shade. At the pairing step you can put the shade in pairing mode using the primary remote control for it (or by accessing the button on the shades motor). Adding the shade to the NEO Smart Blinds app will not affect the normal remote operation.

How Much Does The NEO Smart Blinds App Cost?

The app is a free download, However you must have at least one Simplicity Smart Controller (\$330) to serve as a bridge between the app and your Shades.

Certified Fabrics | GREENGUARD® Fabrics

GREENGUARD Environmental Institute has established performance based standards to define goods with low chemical and particle emissions for use indoors.

The Shangri-La fabrics have the passed GREENGUARD Indoor Air Quality Certified® certification program for low emitting interior building materials, furnishings, and finish systems.

Flame Resistance

Shangri-La fabric may be processed with a topical treatment to resist flames and adhere to strict flammability codes. For more information, contact Customer Service at (800) 843-4151.

UV Protection

Ultraviolet light, entering the home as sunlight, damages furnishings. In time it fades wood floors, furniture, upholstery, draperies, carpeting and artwork. Prolonged exposure to sunlight causes natural, undyed fabrics to turn yellow, weakening their fibers and making them look old and worn prematurely.

The right window covering can be very effective in blocking ultraviolet rays. Such effectiveness is measured in terms of a "% UV blockage" rating. The higher the rating, the greater the UV protection.

Shangri-La fabrics have the following UV Protection ratings:

Light Filtering Fabrics	Open Vanes	87
Room Darkening Fabric	Open Vanes	88
All Fabrics	Closed Vanes	99

Vane Closure

Shangri-La vanes are not designed to close tightly. The inherent nature of the fabric will cause a slight increase in the distance from the front sheer to back sheer as you move further down the shading. These vanes do not form a perfect seal against light leakage which is most visible toward the bottom of the shading. Vane overlap ensures that privacy is not compromised.



Vane closure is measured as the distance between the front and rear fabric sheers 6" up from the lowest point of the bottom rail, with the shading fully lowered and the vanes closed.

On light filtering fabrics, the maximum distance from the front sheer to the back sheer when closed is equal to or less than 5/8" for shadings under 60" and 7/8" for shadings longer than 60". On room darkening fabrics, the distance is 3/8" regardless of shading length.

On all 3" fabrics, the distance is equal to or less than 1".

Vane Opening and Visibility

Vaness on the three styles of Shangri-La fabrics open to slightly different degrees. Consequently, there are variations in visibility through the shadings when the vanes are tilted to their maximum open positions. The variations among the products are shown in the below illustration when looking through the shading 1/4 of the way up from the bottom.

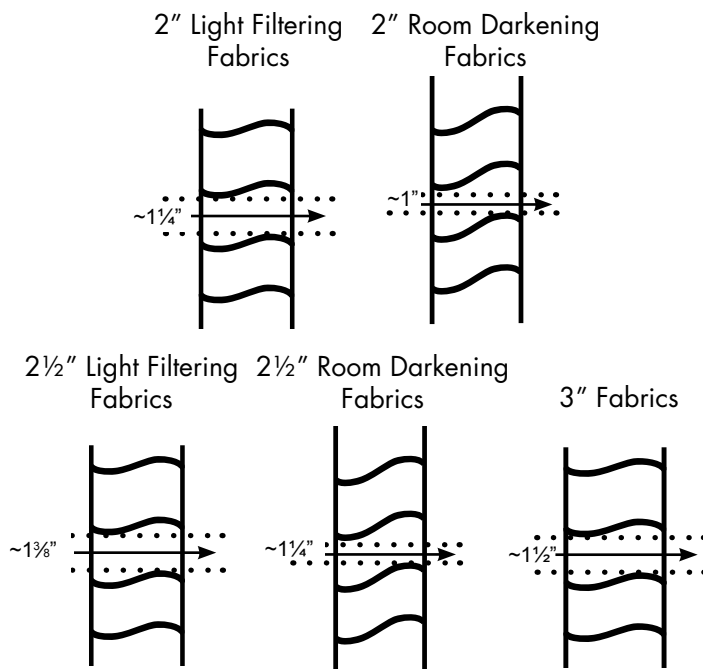

Magnetic Hold-Down Brackets

Optional magnetic hold-down brackets secure the bottom of the shading to prevent swaying. Please specify when ordering.

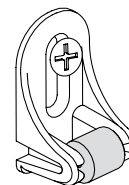

Extension Brackets

Extension or "L" brackets are available to project the back of the shading from the mounting surface. The extension brackets for Designer Cassette head rail projects it 3".

Spacer Blocks

Spacer blocks project the shading 3/8" from the mounting surface. Use spacer blocks to obtain clearance when obstructions, such as window cranks or door handles, obstruct the movement of the shading.

Leveling Shangri-La Sheer Shadings

Shangri-La Window Shadings are leveled and weighted in the factory. When installed level, the fabric will not skew when raised. If the head rail is not installed level, skewing can occur that can damage the edge of the fabric. Be sure to follow the installation instructions carefully to ensure correct and balanced operation.

Measuring Instructions for Sheer Shadings

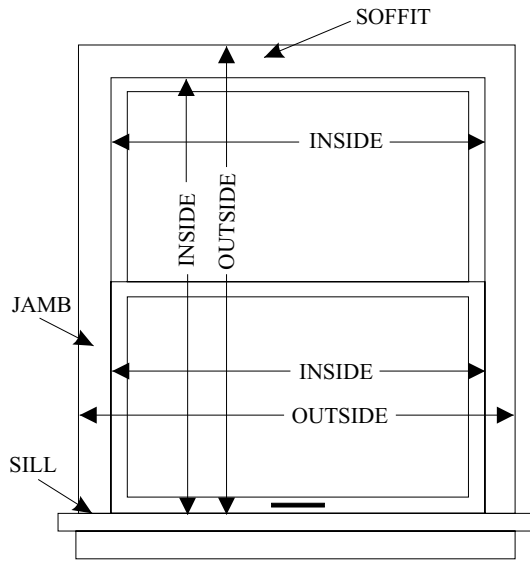

Important Measuring Guidelines for Sheer Shadings. Comfortex accepts measurements down to 1/16" increments.

Precise width and length measurements are critical. Fabric width cannot be altered after the shading is fabricated.

Please use a metal tape measure for accuracy.

The head rail must be installed perfectly level to ensure smooth operation. On an inside mount, it is recommended that you check to see that the mounting surface is level and consistent. If your soffit needs to be leveled, this should be done before measuring.

Inside Mount

Measure across the width of your window opening in three different places - top, middle and bottom. Measurements should be taken within the window jamb. Provide the smallest of the three measurements to Comfortex. Be exact. Comfortex will make the necessary deductions to fit the window opening.

Measure the length of the window opening from the underside of the soffit to the surface of the window sill in two places - use the smallest of these two measurements.

Outside Mount

Measure the exact width and length of the area to be covered. On the width, allow at least 1 1/2" of an overlap on each side. An overlap of 3" on each side is recommended. Be sure to take into consideration any obstructions such as window trim, molding, locks and window cranks.

Side Mount

Side mount is not available with DoorStyles Shadings.

Shangri-La may be side mounted using "L" brackets. For side mounts, follow the instructions for inside mounts. An additional 1/2" will be taken off the standard inside mount deduction to allow room for the "L" brackets.

The maximum shading width utilizing the side mount option is 48".

Skew Adjusting Bottom Rail

After installation, windows that are not square and level may cause the shadings to shift to one side as it rolls up, requiring adjustment of the bottom rail. If the brackets are not level it may be necessary to adjust the bottom rail weight.

- To access the bottom rail weight, release the weight clip on the bottom rail by using a flat blade screwdriver. Insert it into the weight clip in the bottom rail and turn clockwise.
- Move the weight in 1" increments toward the side where the fabric is gathering.
- Secure the weight clips in position by turning them counterclockwise after making the adjustment.

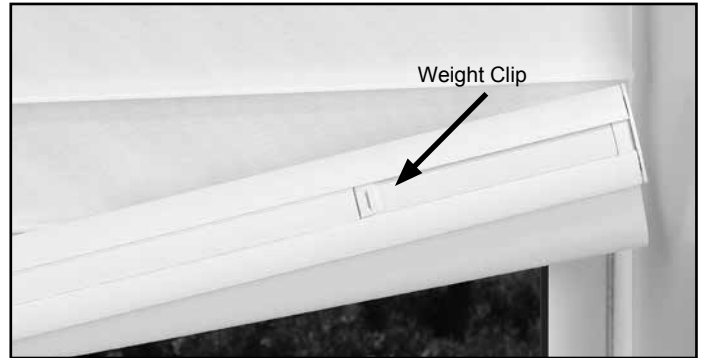

Cleaning and Care

Shangri-La Shadings are made from a sturdy, knitted polyester fabric which can be feather dusted or vacuumed at a low setting. Spots or stains can be lightly rubbed clean with a damp sponge and mild soap. To avoid discoloration of the material, we recommend against the use of chemical cleaners.

Precautions should be taken to reduce exposure to harsh environmental elements, such as salt air. Continuous exposure to salt air through open windows and doors will accelerate fabric deterioration over time.

Important: Do not clean the fabric using electrostatic wipes such as Swiffer® or Pledge Grab-It®.

Ultrasonic Cleaning

Shangri-La Shadings can be ultrasonically cleaned. Adco OnSite Fabricare provides shading and blind cleaning services. For more information, visit www.onsitefabricare.com. Comfortex acknowledges these cleaning methods as being safe and effective. We cannot attest to the quality of equipment or services provided by any independent cleaning facility.

For additional advice on care or cleaning, please contact the Comfortex Technical Service Department at 800-843-4151.

Child Safety

Please see page 94 for child safety information.

Sheer Horizontal Shadings HIGHLIGHTS CORNICE VALANCE



Highlights Cornice Valances

Elevate your windows to a whole new level of design with the Highlights Cornice Valance. Coordinate with other design elements in your room. Add a finishing touch to the top of any window treatment.

The Highlights Cornice Valance is versatile and beautiful at a price point that won't leave you wondering how to cover the rest of your windows!

Choose from any fabric in our Envision™ and PERSONA™ line and customize the valance with our 7 available return sizes to best fit your application.

Easy assembly and quick installation, with the Highlights Cornice Valance, more beautiful windows are within your reach.

Refer to your Envision price list for pricing and specifications.







Soft Tones Shadings



- Soft Tones Sheer Shadings incorporate solid and sheer front fabrics with solid horizontal vanes that provide multiple levels of the light control.
- In the closed position, the fabric allows softly diffused light and offers full privacy.
- In the open position, the vanes filters light through the sheers for gentle illumination.
- Use the cordless PowerTouch or motorized hardware options for a cord free, child safe option.
- Soft Tones Sheer Shadings can be raised up and out of sight into the Designer Cassette Head Rail.
- Soft Tones Sheer Shadings may be ultrasonically or traditionally cleaned to stay bright and beautiful.
- A Limited Lifetime Warranty serves as a commitment to your satisfaction.

Soft Tones Sheer Shadings Hardware Options

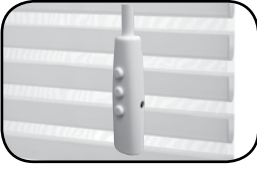
	Key Features	Color Options	Hardware Size (Depth x Height)	Shade Size Available	More Information
<p>Cord Loop</p> 	<ul style="list-style-type: none"> • Cord Loop makes operation easy • Smooth & quiet operation • White, black or bronze loop cord matches your hardware choice. 	<ul style="list-style-type: none"> • White • Black • Bronze 	<p>Smooth Face: 3¾" x 27/8"</p> <p>Fabric Insert: 3¾" x 2¾"</p>	<p>Width: 12" to 96"</p> <p>Length: 12" to 96"</p>	Page 41
<p>Simplicity Motorization</p> 	<ul style="list-style-type: none"> • Raise & lower shade with click of a button • Great for large and hard to reach windows • Remote can operate multiple shades 	<ul style="list-style-type: none"> • Designer Cassette options • 5 Channel Remote • 6 Channel Remote with Timer 	<p>Smooth Face: 3¾" x 27/8"</p> <p>Fabric Insert: 3¾" x 2¾"</p>	<p>Width: 12" to 96"</p> <p>Length: 12" to 96"</p>	Page 45
<p>Simplicity Rechargeable Motorization</p> 	<ul style="list-style-type: none"> • Features a battery powered motor utilizing an integrated rechargeable battery • Raise & lower shading with click of a button • Great for large and hard to reach windows • Remote can operate multiple shades 	<ul style="list-style-type: none"> • Designer Cassette options • 5 Channel Remote • 6 Channel Remote with Timer 	<p>Smooth Face: 3¾" x 27/8"</p> <p>Fabric Insert: 3¾" x 2¾"</p>	<p>Width: 12" to 96"</p> <p>Length: 12" to 96"</p>	Page 47
<p>PowerTouch Rechargeable Cordless Wand</p> 	<ul style="list-style-type: none"> • Raise & lower shading with push of a button • Eliminate the need to stand by the shading to operate; just touch and go • Favorite position button • Rechargeable battery pack with recharge port on pendant 	<ul style="list-style-type: none"> • Wand and pendant available in white or black 	<p>Smooth Face: 3¾" x 27/8"</p> <p>Fabric Insert: 3¾" x 2¾"</p>	<p>Width: 12" to 96"</p> <p>Length: 12" to 96"</p>	Page 43

Soft Tones Sheer Shading Size Standards

		Cord Loop	Simplicity Motorization		PowerTouch Rechargeable
			Standard	Rechargeable	
Soft Tones	Minimum Width	12"	14"	18"	18"
	Minimum Length	12"	12"	12"	12"
MAXIMUMS					
Soft Tones	Maximum Width	96"	96"	96"	96"
	Maximum Length	96"	96"	96"	96"
	Maximum Width for Side Mount	48"	48"	48"	48"

Please Note: Once ordered and manufactured, the width of the Soft Tones fabric cannot be altered. Comfortex makes deductions to the width of Soft Tones Shadings depending on the type of mounting indicated. For all mounting types, the fabric will measure exactly the length ordered when the shading is fully lowered and the vanes are in the closed position.

5 1/2" Soft Tones Vanes

PRICE GROUP 11
Cord Loop

Soft Tones Sheer Shadings

		Width In Inches										
		24	30	36	42	48	54	60	66	72	84	96
Length In Inches	36	439	491	551	602	659	716	769	826	967	1085	1197
	42	462	521	579	643	704	767	826	886	1032	1160	1280
	48	489	552	619	682	747	814	884	953	1100	1233	1366
	54	509	578	650	722	794	866	942	1022	1168	1307	1462
	60	533	611	685	761	836	921	1001	1086	1229	1390	1557
	66	557	640	719	801	886	974	1068	1154	1295	1478	1656
	72	579	668	755	842	935	1032	1127	1223	1366	1560	1754
	78	596	691	782	879	977	1079	1177	1280	1431	1640	1841
	84	621	719	815	925	1027	1133	1244	1352	1505	1728	1941
	90	647	747	852	965	1077	1196	1303	1418	1577	1811	2037
	96	671	779	888	1008	1127	1244	1361	1481	1650	1895	2134

MOTORIZATION	MORE INFO	ADD
PowerTouch Rechargeable	Pg 43	\$149
Simplicity - Motor and Battery Wand	Pg 45	\$439
Simplicity Rechargeable Motorization - Motor with Integrated Battery	Pg 47	\$439
Simplicity Smart Controller (NEO)	Pg 33	\$330
For further details of surcharges	Pg 8	

Soft Tones Sheer Shadings Head Rail Options

CORD LOOP | DESIGNER CASSETTE HEAD RAIL

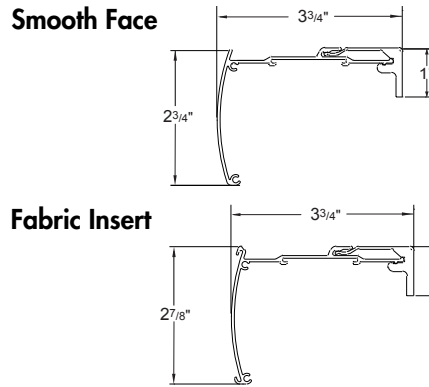

- Smooth Face Designer Cassette Head Rail**
- Depth of rail and bracket: 3 3/4"
 - Height of rail: 2 3/4"
 - Height of bracket: 1"

- Fabric Insert Designer Cassette Head Rail**
- Depth of rail and bracket: 3 3/4"
 - Height of rail: 2 7/8"
 - Height of bracket: 1"

Hardware Features	
Standard Designer Cassette	Choose from coordinating Fabric Insert or painted Smooth Face rail. Default head rail color is White or Ivory based on shading vane color.
Bottom Rail Color	Color coordinated rail with White/Ivory head rail. Bottom rail will be matched to Oil Rubbed Bronze or Onyx Black when metallic upgrade is selected.
Upgrades	
Designer Metallic Upgrade (Fabric Insert/Smooth Face)	<ul style="list-style-type: none"> • Oil Rubbed Bronze • Onyx Black
Mounting Dimensions	
	Designer Cassette Head Rail
Minimum Shallow Mount	1"
Minimum Flush Inside Mount (including brackets)	3 3/4"
Minimum Outside Mount	1"
Minimum Side Mount	1 1/4"
Finished Dimensions	
Inside Mount	
	<ul style="list-style-type: none"> • Fabric will measure ordered width less: 1" • Head rail* will measure ordered width less: 3/16"
Side (End) Mount	
	<ul style="list-style-type: none"> • Fabric will measure ordered width less: 1 1/2" • Head rail* will measure ordered width less: 1 1/16"
Outside Mount	
	<ul style="list-style-type: none"> • Fabric will measure ordered width less: 5/8" • Head rail* will measure ordered width plus: 3/16"
Exact (End Cap to End Cap) Mount	
	<ul style="list-style-type: none"> • Fabric will measure ordered width less: 1 3/16" • Head rail* will measure ordered width
* Head rail measurements include endcaps. Width and length measurements may vary +/- 1/8"	

Please Note: Due to variations in fabric weave and environmental conditions, the finished dimensions for both width and length may vary, plus or minus 1/8", from your order measurements.

Soft Tones Sheer Shadings

DESIGNER CASSETTE HEAD RAIL HARDWARE SYSTEM | SPECIFICATIONS

Soft Tones Sheer Shadings

Soft Tones Shadings incorporate solid and sheer front fabrics with 5½" solid fabric vanes. By aligning the sheer or the solid portion of the fabric, you can control the amount of light that enters the room.

Soft Tones Shadings feature the Designer Cassette Head Rail. Choose from Fabric Insert or Smooth Face.

Soft Tones Sheer Shadings Surcharges

See page 8 for surcharges.

Length Considerations

Comfortex will fabricate your Soft Tones Shadings to the exact length ordered +/- 1/8". The vanes will be in the closed position when the shading is at its full ordered length.

Fabric Positions

Soft Tones Shadings cord loop control provides the ability to manipulate the shading into various viewing positions. There are variations in light control when the solid and sheer horizontal front fabrics and the 5½" vanes are moved into different positions. The following can be obtained with standard shading operation when viewing the shading at eye level.

- **Fully private:** When lowered completely, Soft Tones provides complete privacy and softly diffused light.
- **Partially open:** Opening Soft Tones slightly will gradually increase the level of light and allow varying levels of view through.
- **View-through when lowered:** By completely opening the vanes, Soft Tones provides a softened, veiled view to the outside.
- Soft Tones can be rolled up in reverse. Comfortex recommends that you do not raise the shading more than 24" off this sill in this mode, refer to page 96 for warranty information.

Side By Side Alignment

When Soft Tones Shadings are installed side-by-side, vane alignment can be guaranteed within 1/4" only if:

- The shadings are the same color and ordered at the same time.
- The sum total of the widths of all shadings needing alignment is less than 96".
- Side-by-side lineup is specified when the order is placed.

Product Attributes

Due to the nature of fine woven fabrics, some minor waviness, creases, or bowing may occur. This is considered normal.

Soft Tones Shadings Operation

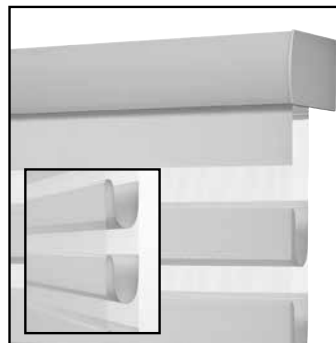

Figure A

By using the cord loop, users can adjust the solid and sheer horizontal front fabrics and 5½" vanes to control the amount of incoming light and the view-through effect (Figure A).

Soft Tones vanes form a "U" shape when the shading is in the open position.

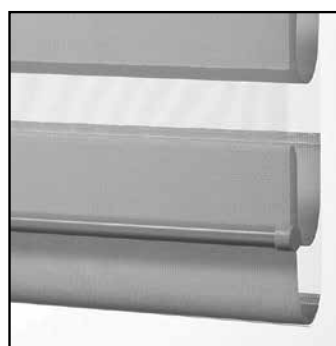

Figure B

Please Note: When the Soft Tones Shadings is fully lowered and in the open position, the back of the fabric will hang lower than the bottom rail (Figure B) but will not touch the sill.



Figure C

When in the closed position, Soft Tones fabric diffuses incoming light, providing a warm glow. The vanes will be in the closed position when the shading is at its full ordered length (Figure C).

Soft Tones Shading Cord Information

A braided cord is used to raise and lower the shading. The cord color will match your hardware choice.

The cord loops will measure the length indicated below unless otherwise specified.

Shading Length	Standard Loop
12" to 26 7/8"	1' (12")
27" to 39 7/8"	2' (24")
40" to 59 7/8"	3' (36")
60" to 83 7/8"	4' (48")
84" to 96"	5' (60")

The continuous cord loop can be ordered in custom lengths in 1' increments only. Maximum cord length is 8 feet. Cord tensioner matches your hardware choice (white, black or bronze).

Soft Tones Sheer Shadings Hardware Options

POWERTOUCH RECHARGEABLE | DESIGNER CASSETTE HEAD RAIL

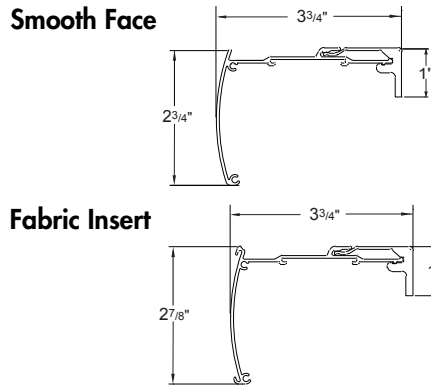
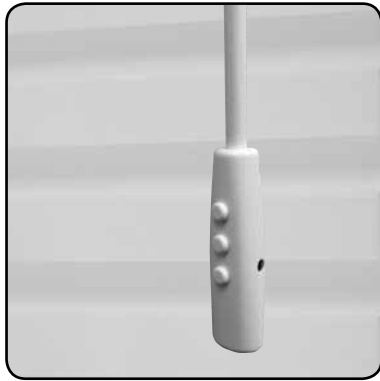

- Smooth Face Designer Cassette Head Rail**
- Depth of rail and bracket: 3 3/4"
 - Height of rail: 2 3/4"
 - Height of bracket: 1"

- Fabric Insert Designer Cassette Head Rail**
- Depth of rail and bracket: 3 3/4"
 - Height of rail: 2 7/8"
 - Height of bracket: 1"

Hardware Features	
Standard Designer Cassette	Choose from coordinating Fabric Insert or painted Smooth Face rail. Default head rail color is White or Ivory based on shading vane color.
Bottom Rail Color	Color coordinated rail with White/Ivory head rail. Bottom rail will be matched to Oil Rubbed Bronze or Onyx Black when metallic upgrade is selected.
Upgrades	Available for all Designer Cassette Head Rails
Designer Metallic Upgrade (Fabric Insert/Smooth Face)	<ul style="list-style-type: none"> • Oil Rubbed Bronze • Onyx Black

Mounting Dimensions	Designer Cassette Head Rail
Minimum Shallow Mount	1"
Minimum Flush Inside Mount (including brackets)	3 3/4"
Minimum Outside Mount	1"
Minimum Side Mount	1 1/4"
Maximum Width Side Mount	48"

Finished Dimensions	
Inside Mount	
	<ul style="list-style-type: none"> • Fabric will measure ordered width less: 1" • Head rail* will measure ordered width less: 3/16"
Side (End) Mount	
	<ul style="list-style-type: none"> • Fabric will measure ordered width less: 1 1/2" • Head rail* will measure ordered width less: 1 1/16"
Outside Mount	
	<ul style="list-style-type: none"> • Fabric will measure ordered width less: 1 3/16" • Head rail* will measure ordered width
Exact (End Cap to End Cap) Mount	
	<ul style="list-style-type: none"> • Fabric will measure ordered width less: 3/16" • Head rail* will measure ordered width

* Head rail measurements include endcaps. Width and length measurements may vary +/- 1/8"

Please Note: Once ordered and manufactured, the width of the Soft Tones fabric cannot be altered. Comfortex makes deductions to the width depending on the type of mounting indicated. For all mounting types, fabric will measure exactly the length ordered when the vanes are in the closed position.

Soft Tones Sheer Shadings

POWERTOCH RECHARGEABLE | DESIGNER CASSETTE HEAD RAIL

PowerTouch™ Rechargeable Shades

Sheer Shadings can be fabricated with the PowerTouch Rechargeable Push Button Control option. The PowerTouch Rechargeable option is an easy, cord free motorized operation for the budget savvy homeowner. PowerTouch Rechargeable uses Simplicity motors and components.

PowerTouch Rechargeable Shades Operation

Press the up or down button on the pendant to raise or lower the shading to your desired position.

No programming is required with PowerTouch™, all programming is set at the factory. Upper and lower limits easily can be adjusted in the field if desired. Favorites position can be programmed on-site. Please refer to the installation instructions at comfortex.com/comfortex-dealers.

PowerTouch Rechargeable Surcharges

See page 8.

PowerTouch Appearance

- The PowerTouch Rechargeable wand and pendant is attached to the head rail and requires no additional mounting.
- The wand and pendant hangs down the front of the shades from the head rail. The wand does not touch the fabric.
- Pendant is 2½" long.



PowerTouch Rechargeable Color Options

- Shadings with Black or Oil Rubbed Bronze hardware will be built with black wand and pendants standard. All other colors will use white wand and pendants.

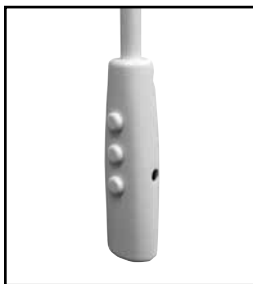

White



Black Shown with Plug-In Charger

PowerTouch Wand and Pendant Location

The standard location for the wand and pendant is on the right. Please specify location when ordering.

PowerTouch Rechargeable Wand Length

The standard length of the wand will measure the indicated below unless otherwise specified.

Shading Length	Standard Wand Length
Up to 30"	1' (12")
>30" to 52"	2' (24")
>52" to 78"	3' (36")
>78" to 100"	4' (48")
>100" to 120"	5' (60")

- Wand length is in 1 foot increments. 1 foot - 5 foot

Mounting Requirements for PowerTouch Rechargeable Shadings

- No special installation hardware or wiring requirements are needed.
- The wand and pendant do not need to be mounted to operate the shading.

PowerTouch Rechargeable Battery Life

The battery life will vary based on the type of window covering selected, the size and weight of the window covering and the number of times you operate the blind on a daily basis.

Battery Charger

8.4 Volt charger requires a standard power outlet to recharge the battery. Must specify charger when ordering a Simplicity PowerTouch Rechargeable Shading. The charger plugs into the charger port. The charger is black and comes with a 156" wire. The dimensions are 1" wide x 2½" length x 1¼" deep.



PowerTouch Rechargeable Shadings Warranty

Please see page 95 for complete warranty information.

Soft Tones Sheer Shadings Hardware Options

SIMPLICITY MOTORIZATION | DESIGNER CASSETTE HEAD RAIL

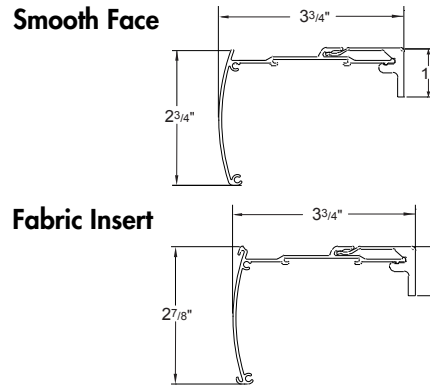

- Smooth Face Designer Cassette Head Rail**
- Depth of rail and bracket: 3 3/4"
 - Height of rail: 2 3/4"
 - Height of bracket: 1"

- Fabric Insert Designer Cassette Head Rail**
- Depth of rail and bracket: 3 3/4"
 - Height of rail: 2 7/8"
 - Height of bracket: 1"

Hardware Features	
Standard Designer Cassette	Choose from coordinating Fabric Insert or painted Smooth Face rail. Default head rail color is White or Ivory based on shading vane color.
Bottom Rail Color	Color coordinated rail with White/Ivory head rail. Bottom rail will be matched to Oil Rubbed Bronze or Onyx Black when metallic upgrade is chosen.
Upgrades	
Designer Metallic Upgrade (Fabric Insert/Smooth Face)	<ul style="list-style-type: none"> • Oil Rubbed Bronze • Onyx Black
Mounting Dimensions	
Designer Cassette Head Rail	
Minimum Shallow Mount	1"
Minimum Flush Inside Mount (including brackets)	3 3/4"
Minimum Outside Mount	1"
Minimum Side Mount	1 1/4"
Maximum Width Side Mount	48"
Finished Dimensions	
Inside Mount	
	<ul style="list-style-type: none"> • Fabric will measure ordered width less: 1" • Head rail* will measure ordered width less: 3/16"
Side (End) Mount	
	<ul style="list-style-type: none"> • Fabric will measure ordered width less: 1 1/2" • Head rail* will measure ordered width less: 1 1/16"
Outside Mount	
	<ul style="list-style-type: none"> • Fabric will measure ordered width less: 5/8" • Head rail* will measure ordered width plus: 3/16"
Exact (End Cap to End Cap) Mount	
	<ul style="list-style-type: none"> • Fabric will measure ordered width less: 13/16" • Head rail* will measure ordered width
* Head rail measurements include endcaps. Width and length measurements may vary +/- 1/8"	

Please Note: Once ordered and manufactured, the width of the Soft Tones fabric cannot be altered. Comfortex makes deductions to the width depending on the type of mounting indicated. For all mounting types, fabric will measure exactly the length ordered when the vanes are in the closed position.

Soft Tones Sheer Shadings

SIMPLICITY MOTORIZATION | DESIGNER CASSETTE HEAD RAIL

Simplicity Motors

The Simplicity Motor program features a battery powered motor utilizing a single battery wand or plug-in DC transformer. Simplicity motors are compact and use a radio frequency remote to raise or lower the shadings. The Simplicity motor is concealed in the head rail.

See page 47 for information on Simplicity Rechargeable system version.

Simplicity Motors With Designer Cassette

No special installation hardware or wiring requirements are needed to install motorized Shangri-La Shadings with Designer Cassette Head Rail. See page 45 for mounting information.

Simplicity Battery Wand

The battery wand can be clipped to the Designer Cassette head rail. Can not be mounted on shadings under 25" wide. The battery wand is wall or ceiling mounted utilizing white battery wand clips. The 12 volt battery wand measures 17¼", and comes with eight alkaline batteries, and is white in color. The battery wand must be placed so it does not interfere with the mounting brackets.

The battery wire is 10" long. A 48" extension wire is available.



Simplicity Motor Battery Life and Replacement

Eight alkaline batteries are included with the wand. The battery life will vary based on the type of window covering selected, the size and weight of the window covering and the number of times you operate the shade on a daily basis.

Comfortex will warranty batteries for up to 3 months from date of purchase. Batteries are not covered by the warranty.

DC Power Supply/Transformer

12 Volt DC power supply/transformer is available and requires a standard power outlet to power the motor. The transformer is an alternative to a battery wand. Each transformer can power a single shading. The power supply must plug in to the motor. The DC power supply is white and comes with a 80" wire. The dimensions are 1⅞" wide x 3¼" long x 1¼" deep. Extension wires are available if needed.



Important Simplicity Motorized Shading Operating and Installation Information

Simplicity Motorized Shadings installed into windows with metal casings may have a reduced radio frequency range, or may not operate at all, depending on the application

Simplicity Motor Hand Held Remotes

5 Channel Remote

The **5 Channel (5C) remote** can operate up to five shadings simultaneously, individually or in groups. **WHEN ORDERING PLEASE SPECIFY WHICH CHANNELS ARE ASSIGNED TO EACH SHADING OR GROUP OF SHADINGS.**

For example; program line 1 to channel 1, line 2 and 3 to channel 2, etc. If no channels are assigned at time of order, all shadings will be programmed to Channel 1.

Simplicity (5C) remotes and holders are black or white in color. The remote comes with a holder which can be mounted to a wall for easy storage. The range of the remote is approximately 80 feet.



6 Channel Timer Remote

The **6 Channel (6C) timer remote** combines the functionality of a six channel hand-held control with the convenience of a programmable timer.

- The 6C timer remote allows for 18 different scheduled actions.
- Manual function disables the timer and the remote then operates as a hand held remote.

Simplicity (6C) remotes and holders are available in white. The remote comes with a holder which can be mounted to a wall for easy storage. The range of the remote is approximately 80 feet.



WHEN ORDERING PLEASE SPECIFY WHICH CHANNELS ARE ASSIGNED TO EACH SHADING OR GROUP OF SHADINGS.

For example; program line 1 to channel 1, line 2 and 3 to channel 2, etc. If no channels are assigned at time of order, all shadings will be programmed to Channel 1.

Simplicity Battery Operated Motorized Shadings Warranty

Please see page 95 for complete Comfortex warranty information.

Soft Tones Sheer Shadings Hardware Options

SIMPLICITY INTEGRATED RECHARGEABLE MOTORIZATION



Smooth Face

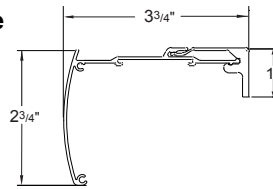

Fabric Insert

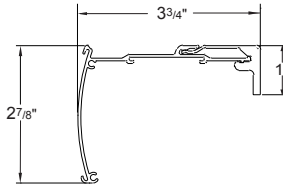

Smooth Face Designer Cassette Head Rail

- Depth of rail and bracket: 3 3/4"
- Height of rail: 2 3/4"
- Height of bracket: 1"

Fabric Insert Designer Cassette Head Rail

- Depth of rail and bracket: 3 3/4"
- Height of rail: 2 7/8"
- Height of bracket: 1"

Hardware Features	
Standard Designer Cassette	Choose from coordinating Fabric Insert or painted Smooth Face rail. Default head rail color is White or Ivory based on shading vane color.
Bottom Rail Color	Color coordinated rail with White/Ivory head rail. Bottom rail will be matched to Oil Rubbed Bronze or Onyx Black when metallic upgrade is selected.
Upgrades	
Designer Metallic Upgrade (Fabric Insert/Smooth Face)	<ul style="list-style-type: none"> • Oil Rubbed Bronze • Onyx Black
Mounting Dimensions	
Designer Cassette Head Rail	
Minimum Shallow Mount	1"
Minimum Flush Inside Mount (including brackets)	3 3/4"
Minimum Outside Mount	1"
Minimum Side Mount	1 1/4"
Minimum Flush Side Mount	1 5/8"
Finished Dimensions	
Inside Mount	
	<ul style="list-style-type: none"> • Fabric will measure ordered width less: 1" • Head rail* will measure ordered width less: 3/16"
Side (End) Mount	
	<ul style="list-style-type: none"> • Fabric will measure ordered width less: 1 1/2" • Head rail* will measure ordered width less: 1 1/16"
Outside Mount	
	<ul style="list-style-type: none"> • Fabric will measure ordered width less: 5/8" • Head rail* will measure ordered width plus: 3/16"
Exact (End Cap to End Cap) Mount	
	<ul style="list-style-type: none"> • Fabric will measure ordered width less: 1 3/16" • Head rail* will measure ordered width
	* Head rail measurements include endcaps. Width and length measurements may vary +/- 1/8"

Please Note: Once ordered and manufactured, the width of the Soft Tones fabric cannot be altered. Comfortex makes deductions to the width depending on the type of mounting indicated. For all mounting types, fabric will measure exactly the length ordered when the vanes are in the closed position.

Soft Tones Sheer Shadings

SIMPLICITY INTEGRATED RECHARGEABLE MOTORIZATION HEAD RAIL

Simplicity Rechargeable Motors

The Rechargeable Simplicity Motor program features an integrated rechargeable lithium ion battery in the motor casing and is fully concealed by the roller tube.

PowerTouch Integrated Rechargeable Surcharges

See page 39 for shading standards and page 8 for surcharges and pricing example.

Simplicity Rechargeable Motors

No special installation hardware or wiring requirements are needed to install motorized Shangri-La Shadings with Designer Cassette Head Rail. No external battery wand is required. See page 47 for mounting information.

Rechargeable Simplicity Motor Batteries

The battery for the integrated rechargeable simplicity motor system is integrated within the motor casing and is fully concealed by the roller tube.

Rechargeable battery comes fully charged from the factory.

Integrated Rechargeable Motor Battery Life

Rechargeable battery is included with the motor.

The average battery charge will last 6-12 months based on an average sized shade raised and lowered once per day. The life of the battery charge will vary based on the type of window covering selected, the size and weight of the window covering and the number of times the shade is operated on a daily basis.

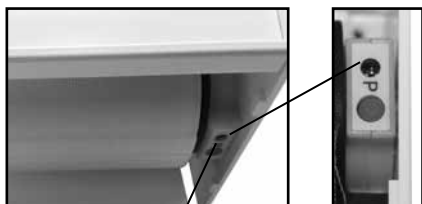

Charging Port

Close-Up

The battery can be recharged up to 500 times. It takes approximately 5 hours to recharge the motor when fully depleted.

Integrated Rechargeable Motor Battery Charger

An 8.4 Volt charger requires a standard power outlet to recharge the battery. The charger must be specified when ordering an Integrated Rechargeable Simplicity Motorized shade. The charger plugs into the charging port of the motor. Required with Integrated Shading order. Sold separately.



The charger is black and comes with a 156" wire. The dimensions are 1" wide x 2½" length x 1¼" deep.

Simplicity Motor Hand Held Remotes

IMPORTANT: Simplicity Rechargeable Motorized Shadings are programmed at the factory with the "up and down" limits. The shades are **UNLINKED** from the remote so they are not able to operate during shipping. Each shade should be installed **before** linking it to the remote.

5 Channel Remote

The **5 Channel (5C) remote** can operate up to five shadings simultaneously, individually or in groups.

Simplicity (5C) remotes and holders are black or white in color. The remote comes with a holder which can be mounted to a wall for easy storage. The range of the remote is approximately 80 feet.



6 Channel Timer Remote

The **6 Channel (6C) timer remote** combines the functionality of a six channel hand-held control with the convenience of a programmable timer.

- The 6C timer remote allows for 18 different scheduled actions.
- Manual function disables the timer and the remote then operates as a hand held remote.



Simplicity (6C) remotes and holders are available in white. The remote comes with a holder which can be mounted to a wall for easy storage. The range of the remote is approximately 80 feet.

Please Note:

- Not all motors run at the same rate of speed.
- Simplicity motors have a "Favorites" or "MY" position setting. If the homeowner wants to set several shadings at the same intermediate position, follow instructions provided with installation manual.
- **WHEN ORDERING THE NEW INTEGRATED RECHARGEABLE, PLEASE ORDER THE NECESSARY BATTERY CHARGER.**

Solar Panel Recharge Option

Plugs in to any Simplicity Rechargeable Remote control shade (does not work with PowerTouch). See page 32.



Dimensions of panel
18½" x 1½"

Sheer Horizontal Shadings SIMPLICITY INTEGRATED RECHARGEABLE MOTORIZATION

Important Information about Integrated Rechargeable Simplicity Motor Shading Operation and Installation

- Simplicity Motorized Shadings installed into windows with metal casings may have a reduced radio frequency range, or may not operate at all, depending on control.
- Be mindful of when your shade starts to slow down during operation. It is a good indicator the shade needs to be recharged.

Retrofit Existing Standard Simplicity Motorized Shadings with Rechargeable Batteries

Sheer shadings made with Standard Simplicity Motorization can be retrofitted with the NEW Rechargeable Simplicity Motorization External Battery Wand. The Rechargeable battery wand is 22" long, comes with 10 NiMH batteries, and is white in color. Battery wands are charged at the factory.

To retrofit the rechargeable battery wand to an existing shading with a cassette head rail, you must have at least 24" between bracket centerlines to fit the battery wand. Otherwise, the wand must be placed elsewhere along the window. Wall mounting clips are provided with the wand.

Retrofit Ordering Requirements:

- Rechargeable battery wand with clips (one per shade)
- Rechargeable battery charger (one or more per order, or as needed)
- Charging port mounting base (optional)

Please contact customer service for more information.



Battery Wand for Rechargeable Simplicity

Simplicity Battery Operated Motorized Shadings Warranty

Please see page 95 for complete Comfortex warranty information.



Hardware | Designer Cassette

Hold Down Brackets

Hold down brackets are made of a clear plastic which fit into holes in the endcap of the bottom rail. The shading **will not** be able to be operated when the bottom rail is connected to the hold down brackets.

Extension Brackets

Extension or "L" brackets are available to project the back of the shading from the mounting surface. The extension brackets for Designer Cassette projects it up to 3".

Spacer Blocks

Spacer blocks project the shading $\frac{3}{8}$ " from the mounting surface. Use spacer blocks to obtain clearance when obstructions, such as window cranks or door handles, obstruct the movement of the shading.

Cleaning and Care

Soft Tones Sheer Shadings fabric is made from a sturdy, woven polyester fabric which can be feather dusted or vacuumed at a low setting. Spots or stains can be lightly rubbed clean with a damp sponge and mild soap. To avoid discoloration of the material, we recommend against the use of chemical cleaners.

Ultrasonic Cleaning

Soft Tones Sheer Shadings can be ultrasonically cleaned. Adco OnSite Fabricare provides shading and blind cleaning services. For more information, visit www.onsitefabricare.com. Comfortex acknowledges these cleaning methods as being safe and effective. We cannot attest to the quality of equipment or services provided by any independent cleaning facility.

For additional advice on care or cleaning, please contact the Comfortex Technical Service Department at 800-843-4151.

Child Safety

Please see page 94 for child safety information.

Highlights Cornice Valance

Please see page 36 for more information.

Measuring Instructions for Soft Tones Shadings

See page 93 for more information.

Vertical Sheer Shadings



- Vertical Sheer Shadings combine the elegance and softness of sheer shadings with the light control of vertical blinds giving you unlimited ways to control light.
- Vertical Sheer Shadings are available up to 192" wide and to heights up to 120". Vertical Sheer Shadings are perfect for wide expanses of windows and doors.
- Vertical Sheer Shadings are available in six neutral colors, all made of 100% polyester that is durable yet soft to the touch.
- A combination wand and cord and moving wand operating systems have no dangling cords to ensure child safety.
- For a coordinated look, Vertical Sheer Shadings can be paired with Shangri-La® Sheer Horizontal Window Shadings.
- Our Vertical Sheer Shadings are beautiful and smart with the added benefit of 99% UV protection to protect artwork and home furnishings from the damaging effects of the sun.
- Vertical Sheer Shadings are custom crafted and assembled in the U.S. and backed by the Comfortex Lifetime Guarantee.

Vertical Sheer Shading Size Standards

		Wand/Cord	Moving Wand*
Vertical Sheer Shadings	Minimum Width	12"	12"
	Minimum Length	24"	24"
MAXIMUMS			
Vertical Sheer Shadings	Maximum Width	192"	144"
	Maximum Length	120"	100"

Please Note: Two side stack shadings (one left and one right) may be abutted to achieve larger maximum widths. This is not recommended with moving wands.

*Moving wand is only available with outside mount side stack shadings.



Vertical Shadings Panel Design

Comfortex Vertical Sheer Shadings features contoured sheer fabric columns with soft 3½" fabric vanes attached.

The top of the Vertical Sheer Shadings features a 5¼" fabric header that conceals the hardware.

Choose from light filtering or room darkening vanes.

Finished Dimensions	
Inside/Ceiling Mount	
Fabric Width	<ul style="list-style-type: none"> Fabric will measure ordered width less: ¼" Side Stack Head rail will measure ordered width less: 1½" Split Stack Head rail will measure ordered width less: 1¼"
Fabric Length	<ul style="list-style-type: none"> Fabric will measure ordered length (overall) less: 1" Top Clearance will measure ordered length less: ½" Bottom Clearance will measure ordered length less: ½"
Fabric Header Height	<ul style="list-style-type: none"> 5¼"
Outside Mount	
Fabric Width	<ul style="list-style-type: none"> Fabric will measure ordered width Side Stack Head rail will measure ordered width less: 1¼" Split Stack Head rail will measure ordered width less: 1"
Fabric Length (for top clearance)	<ul style="list-style-type: none"> Fabric will measure ordered length minus: ½"
Fabric Header Height	<ul style="list-style-type: none"> 5¼"

Please Note: Width and length measurements may vary +/- 1/8"

3½" Vertical Sheer Shadings

PRICE GROUP 12
Light Filtering

Vertical Sheer Shadings

		Width In Inches																	
		24	36	48	54	60	66	72	78	84	90	96	108	120	132	144	156	174	192
Length In Inches	48	988	1228	1442	1547	1660	1806	1914	2021	2139	2291	2434	2623	3137	3467	3706	3940	4176	4521
	60	1097	1373	1630	1756	1898	2072	2195	2321	2459	2635	2799	3024	3561	3915	4174	4431	4678	5058
	72	1195	1551	1875	2028	2195	2386	2545	2693	2862	3069	3251	3745	4352	4784	5105	5440	5754	6250
	84	1279	1680	2088	2260	2440	2661	2827	3006	3180	3410	3619	3915	4542	4984	5325	5673	6006	6512
	96	1381	1821	2208	2384	2582	2811	2995	3182	3373	3625	3838	4247	4906	5388	5755	6134	6508	7062
	108	1649	2172	2676	2923	3210	3522	3758	4008	4249	4546	4810	5218	5853	6336	6716	7099	7448	8017
	120	1854	2438	3032	3319	3688	4061	4335	4632	4923	5257	5547	6031	6621	7101	7477	7858	8175	8730

Solid lines indicates the maximum width and length of Vertical Sheer Shadings available with a Moving Wand.

3½" Vertical Sheer Shadings

PRICE GROUP 13
Room Darkening

		Width In Inches																	
		24	36	48	54	60	66	72	78	84	90	96	108	120	132	144	156	174	192
Length In Inches	48	1162	1442	1693	1819	1951	2123	2252	2375	2515	2693	2860	3082	3688	4075	4358	4634	4907	5317
	60	1291	1615	1916	2065	2228	2436	2580	2728	2890	3092	3291	3553	4184	4601	4903	5208	5496	5949
	72	1406	1825	2203	2384	2580	2807	2993	3167	3364	3603	3821	4397	5111	5622	5998	6395	6763	7348
	84	1504	1973	2457	2655	2871	3127	3325	3534	3743	4006	4247	4599	5336	5858	6258	6668	7058	7653
	96	1621	2139	2594	2803	3036	3305	3522	3745	3967	4253	4506	4990	5764	6330	6762	7207	7647	8301
	108	1938	2551	3147	3434	3775	4138	4419	4714	4996	5343	5651	6130	6877	7444	7892	8341	8756	9420
	120	2180	2868	3563	3901	4335	4773	5099	5445	5790	6175	6515	7088	7779	8341	8784	9232	9608	10260

Solid lines indicates the maximum width and length of Vertical Sheer Shadings available with a Moving Wand.

LIFT SYSTEM AND DESIGN UPGRADES		ADD
	Split Stack Moving Wand (Available on Outside Mount Shadings only)	\$453 FREE

Product Configurations

Choose from three stacking designs: left stack, right stack or split stack.

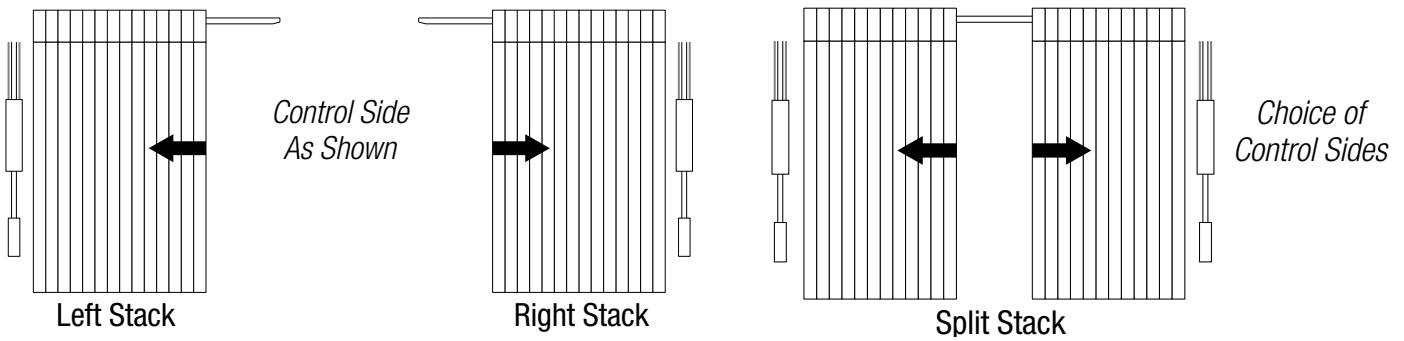

Inside Mount Finished Dimensions

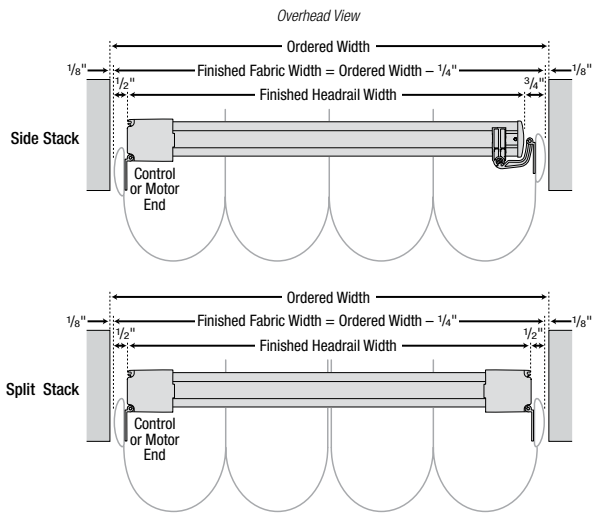

Outside Mount Finished Dimensions

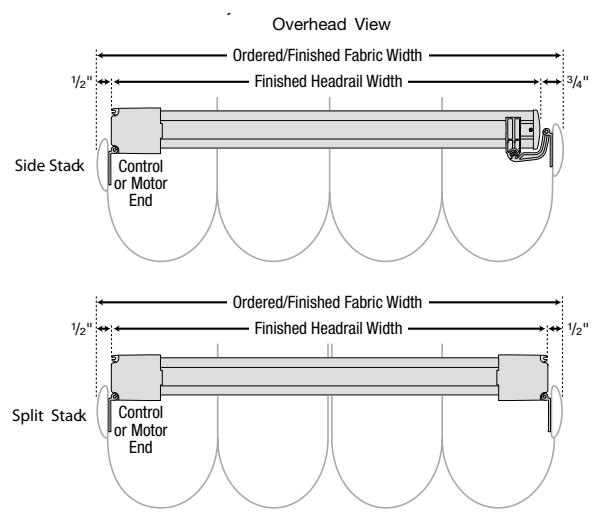

Vertical Sheer Shadings Fabrics and Vanes

Vertical Sheer Shadings are a beautiful option for covering for a variety of windows. However, they are a textile product which will never be perfect. By understanding some of the qualities of the fabric used in Vertical Sheer Shadings, you will be able to set clear expectations during the sales process.

Fabric and Vanes

- Vertical Sheer Shadings are 100% polyester for durability and easy care. The 3 1/2" stationary vanes are permanently bonded to the rear of the face fabric, providing a uniform appearance to the home's exterior.
- Color is carried by the sheer fabric; vanes are white. Vanes available in two opacities: light filtering and room darkening.
- The Vertical Sheer Shadings fabrics are subject to the variations associated with all textiles, such as slight wrinkles or puckers.

Tiltback

Additional weight of the face fabric in front causes the fabric to hang at a slight angle, called "tiltback." This is an inherent characteristic of the product and may be more noticeable on shorter panels.

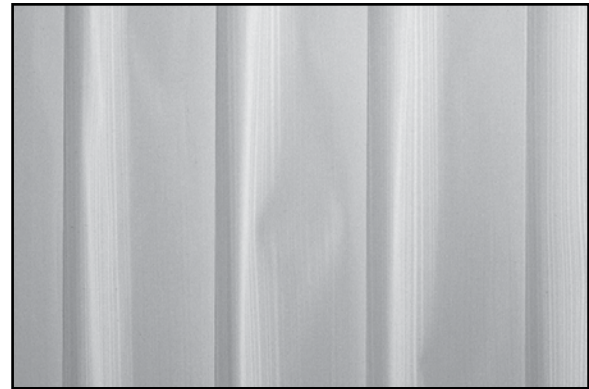
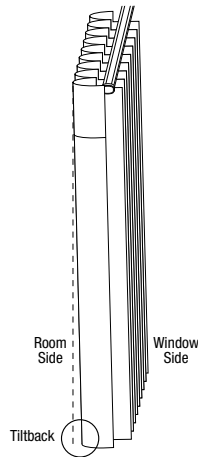

Puckering



Tilt Back



Vertical Sheer Shadings Hardware

Vertical Sheer Shadings use a proven scissor track system. Track system is white and hidden behind the fabric header.

Scissors expand when the sheer is drawn closed and compress when the sheer is drawn open.

Vane realignment is easy — rotate the vanes first to one side and then the other.



Controls and Control Placement

Vertical Sheer Shadings are operated with wand/cord combination or a moving wand option.

Wand/Cord Control

- With the wand/cord, pull the cord to traverse the fabric and twist the wand to rotate the vanes. Be sure to use both hands to avoid twisting the cord.
- Wand/cord placement: the shading stacks on same side as wand/cord; for split stack or offset stack, choose left or right control.
- See the next column for standard wand/cord lengths.



Moving Wand

- The moving wand is a cordless wand control system that traverses the fabric and rotates the vanes.
- Moving wand is available with **outside mount shadings only**.
- The placement of moving wand is opposite side of stack.
- See the next column for standard wand lengths.



Wand/Cord Lengths

- Wand/cord length is measured from top of fabric to bottom of wand.
- **Placement:** Wand/cord: the shading stacks on same side as wand/cord; for split stack or offset stack, choose left or right control.

Ordered Shading Length	Standard Wand/Cord Length
24" to 40"	24"
40 $\frac{1}{8}$ " to 60	36"
60 $\frac{1}{8}$ " to 96"	48"
96 $\frac{1}{8}$ " to 108"	60"
108 $\frac{1}{8}$ " to 120"	72"

- Custom lengths for the wand/cord may be specified when ordering. Choose from 24", 36", 48", 60" and 72" lengths at no additional charge.
- Non-standard wand/cord lengths are not available.

Moving Wand Length

- Wand length is measured from top of fabric to bottom of wand.
- **Placement:** Moving wand: the shading stacks on opposite side of wand; available on outside (OB) mount side stack only.

Ordered Shading Length	Wand Length
24" to 48"	23"
48 $\frac{1}{8}$ " to 84"	30"
84 $\frac{1}{8}$ " to 100"	40"

Vertical Sheer Shadings Design and Operation

Outside Mount Installation

Specifying Vertical Sheer Shadings as outside mounts is ideal because the vanes and fabric are allowed to operate freely.

- Outside mounts provide complete fabric coverage and enhance light control and privacy features.
- Outside mounts allow the shading to be stacked back off of the window opening for an unobstructed view.

WHY INSIDE MOUNTS ARE NOT RECOMMENDED

- Vertical Sheer Shadings are not recommended as inside mounts due to light gaps that occur on the sides of the sheer when the vanes are closed.
- Inside mounting prevents the end treatments from rotating with the vanes. This results in light gaps on the sides of the sheer when the vanes are closed, as well as compressed end fabrics.

Vane Closure Gap

The closed vanes of Vertical Sheer Shadings are designed to overlap for privacy when viewed straight on.

- Light leakage may occur due to the vane closure gap, which may increase with the length of the shading.
- The vane closure gap is most visible when viewed from the side. It is a normal, inherent characteristic of the product and should not be considered a defect.
- Vane closure is tighter in one direction than the other when the vanes are rotated closed.

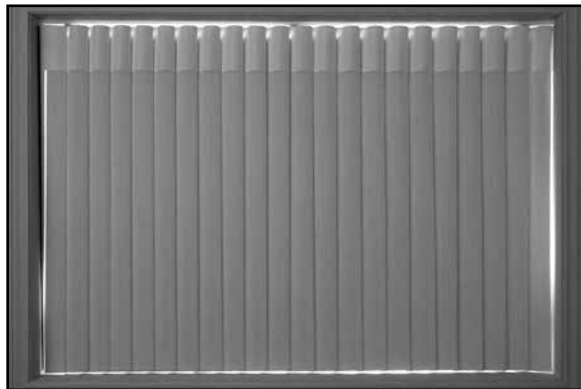
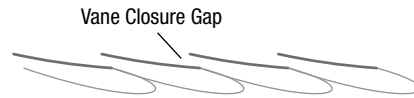

Light gaps around the window frame that occur with Inside Mount Shadings

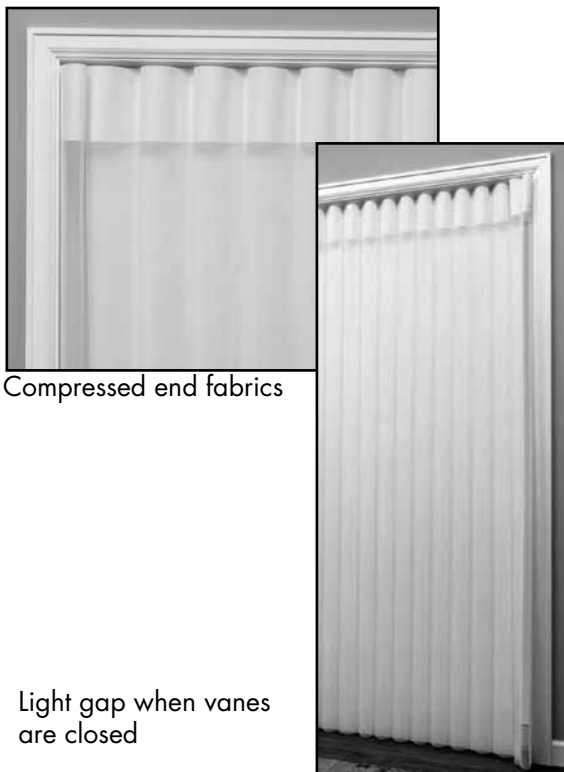

Compressed end fabrics

Light gap when vanes are closed

Split Stack Center Gap

- The maximum distance between fabric panels of a split stack design is $\frac{1}{4}$ ".

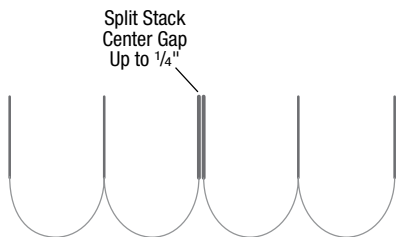

Side-By-Side (Abutted) Applications

- Outside-mounted side stack shadings may be abutted at the non-control ends to achieve wider widths up to 384".
- Abutted applications utilize two independent head rails and will appear and function differently than a split stack application utilizing a single head rail.
- No deductions or special order entries are necessary.
- At installation, position the ends of the rails $1\frac{1}{2}$ " apart for optimal appearance and function.
- Please Note:** The moving wand is not recommended for abutted applications.

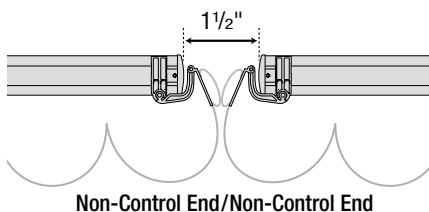

Abutted Gap

- For best closure on shadings with abutted installations, the vanes should be rotated in opposite directions to minimize the abutted gap, as shown below.

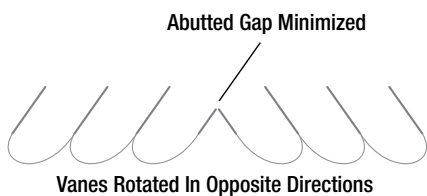
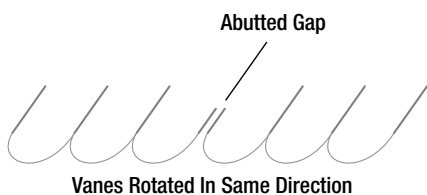

Return Gaps

Outside mount applications have return gaps, which is the distance between the end treatments and the wall.

Gap Dimensions

Return Gap — Side Stack

- Control (wand/cord) end 2"
- Non-control (traveling) end $1\frac{1}{2}$ "

Return Gap — Split Stack

- Both ends 2"

Center Gap

- Split stack up to $\frac{1}{4}$ "

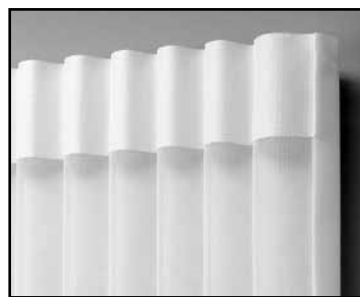
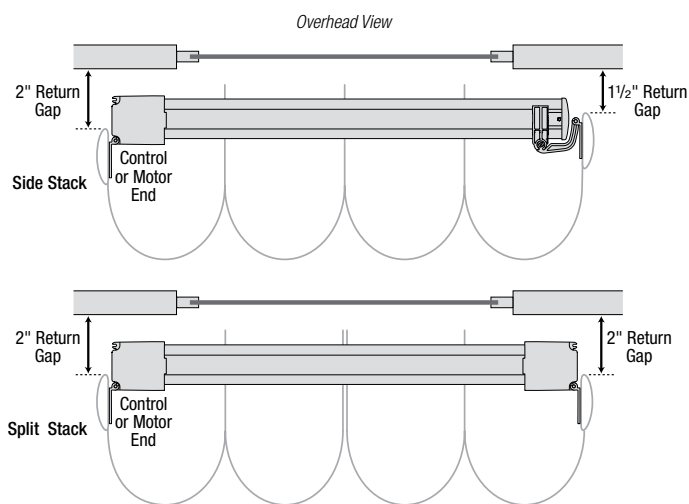

Return gap

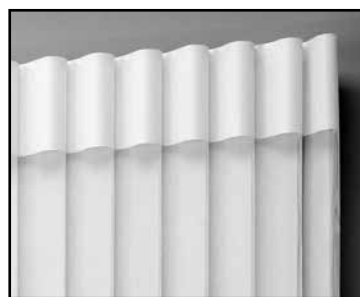

All vanes fully rotate

Measuring, Mounting Requirements and Installation Information

- Outside mount applications are highly recommended. Inside mount installations **are not recommended** due to the light gaps that occur when the vanes are closed.
- Moving wands control option is only available with outside mount side stack shadings.
- **Top clearance is required for head rail installation.** The rail must be tilted upward to fit into the installation bracket faceplate.

Installation Brackets

- Installation bracket faceplates with spacer blocks are used for outside mounts.
- Inside/ceiling mount brackets are used for inside and ceiling mounts. These brackets are also used with extension brackets for outside mounts needing extra clearance.

Ordered Width	Installation Brackets Required
Up to 40"	2
40 $\frac{1}{8}$ " to 70"	3
70 $\frac{1}{8}$ " to 96"	4
96 $\frac{1}{8}$ " -155"	6
155 $\frac{1}{8}$ " -192"	8

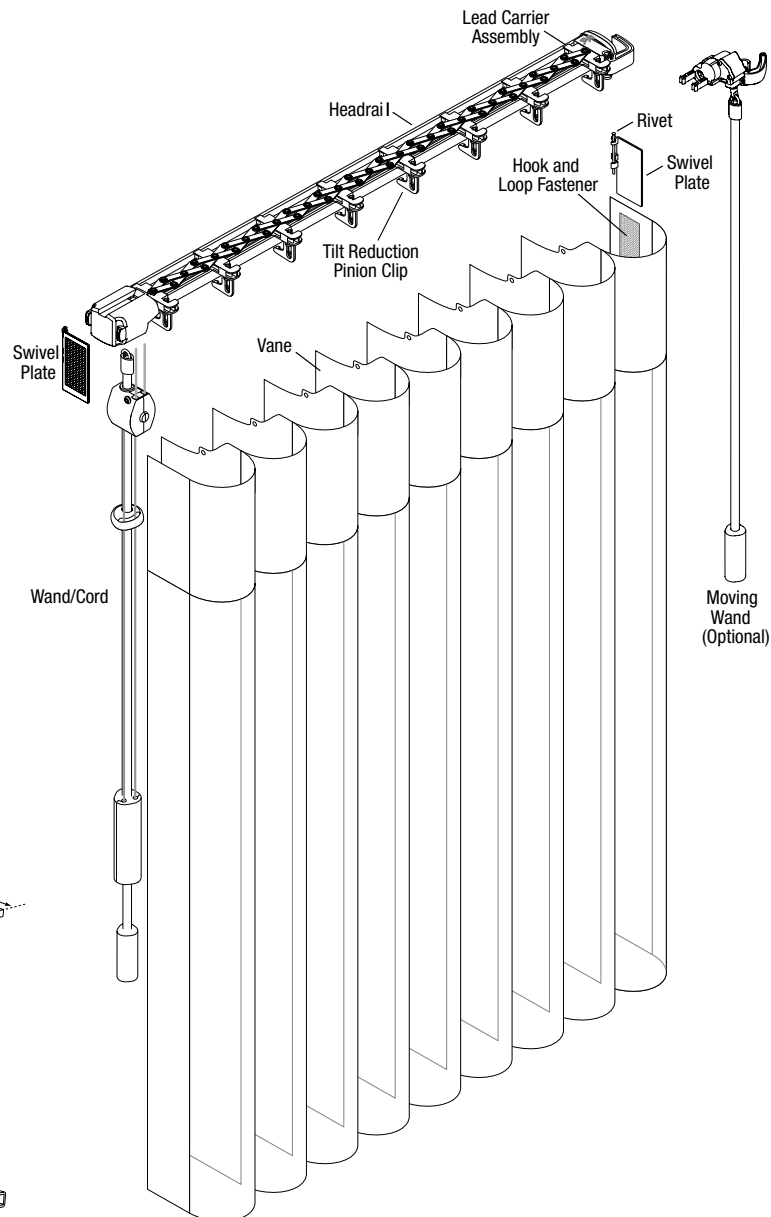
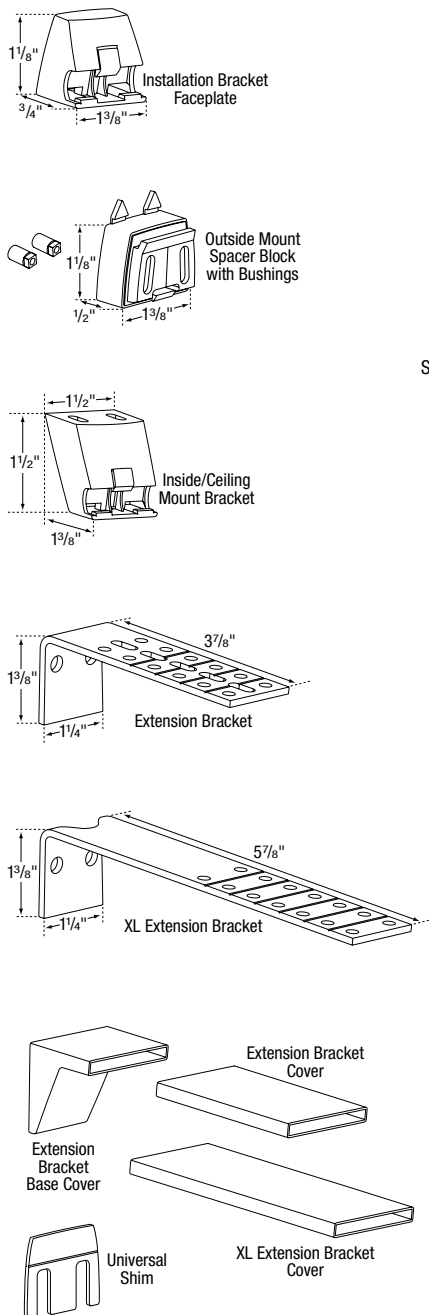

Measuring, Mounting Requirements and Installation Information

Outside Mount

- Minimum mounting surface height with Standard Bracket: 1 1/8"
- Minimum mounting surface height with Extension Bracket: 1 3/8"
- Recommended top overlap: 5"
- Recommended minimum overlap per side (and bottom overlap when product does not hang to floor): 5"
- Recommended bottom clearance when product hangs to floor (deduct before ordering): 1/2"

Outside Mount Ordered Height

- Outside mount ordered height is the distance from the bottom of the fabric to 1/2" above the top of the fabric, where the top of the bracket tab will be located.
- When measuring, plan on the bottom of the fabric being located a minimum of 1/2" above the floor for operating clearance.
- Allow the recommended amount of top overlap and check that the bracket can be mounted on a 1 1/8" flat, not curved, vertical surface.

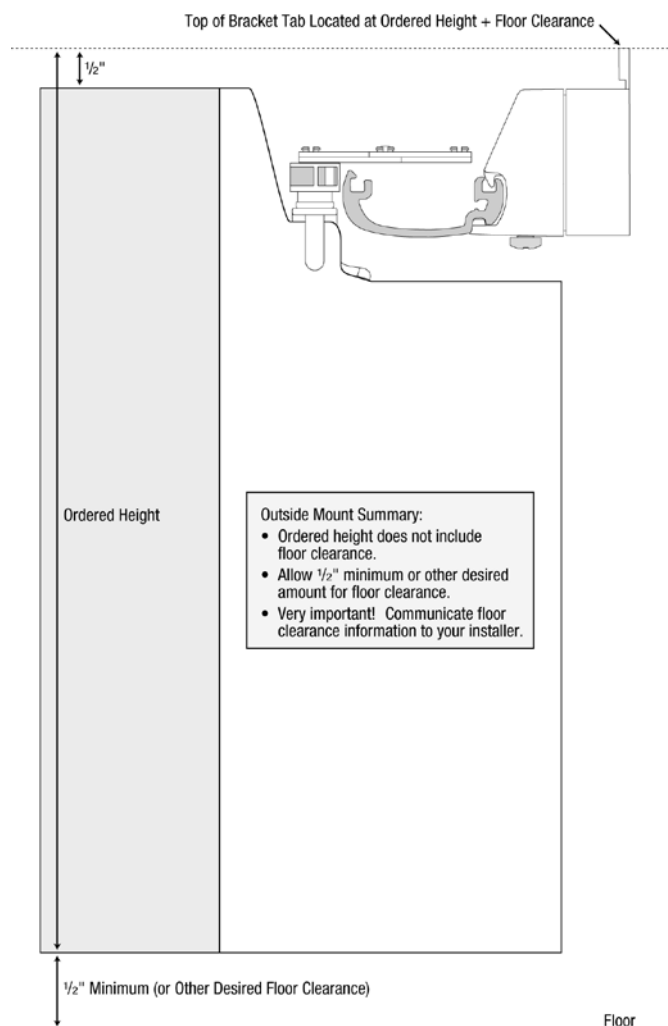

Inside/Ceiling Mount

Inside/ceiling mount brackets are used for inside and ceiling mounts. These brackets are also used with extension brackets for outside mounts needing extra clearance.

- Minimum mounting depth: 1"
- Minimum mounting depth, fully recessed: 6 1/4"

Spacer Blocks

- Each spacer block projects an outside mount installation bracket 1/2" away from the mounting surface.
- There must be sufficient rear clearance for proper operation.
- One spacer block is required for the 3 1/2" vane size.

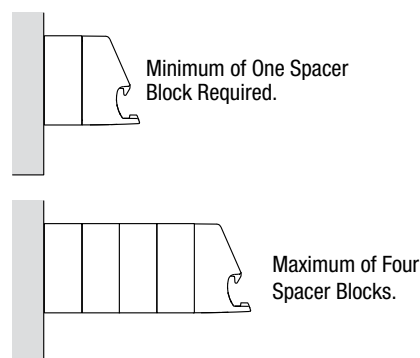

Extension Brackets

- Standard extension brackets can provide up to 3 1/2" of clearance.
- Extra Large extension brackets can provide up to 5 1/2" of clearance.

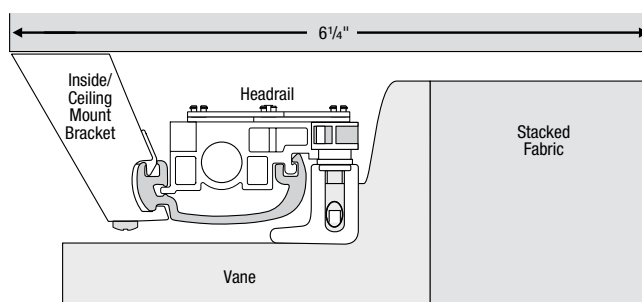

Measuring for Corner Windows

- Measure the width of both openings to the common corner.
- Deduct the depth of the treatment from the width of each measurement so they will meet in the corner but not overlap. Deduct 3".
- If additional spacer blocks or extension brackets will be used for extra clearance on outside mounts, add the amount of extra clearance to the deduction.
- Order the width less the deduction for each window.

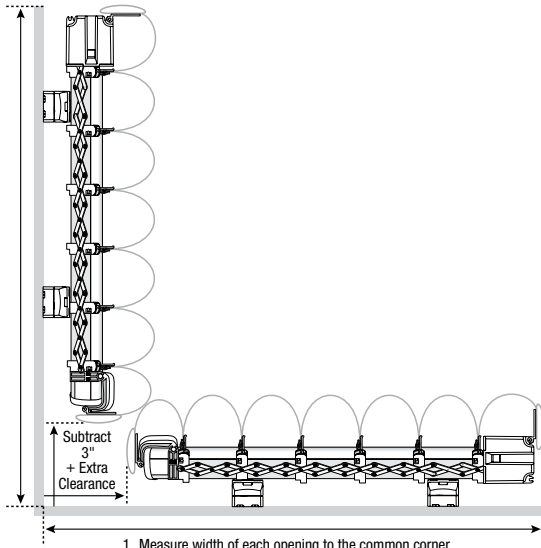

1. Measure width of each opening to the common corner.
2. Subtract 3" for vane size plus any extra clearance.

How to Avoid Common Ordering Errors

- If an outside mounted Vertical Sheer Shading hangs to the floor, allow for a minimum of 1/2" for floor clearance.
 - Allow for more clearance, if needed (with thick pile carpet, for example).
 - Be sure the installer understands your floor clearance allowance so that he or she mounts the brackets at the proper height.
- Be sure to measure for the recommended outside mount height and width overlaps. Include Stackback, if desired (see pages 62-63).
- With side stack Vertical Sheer Shadings, specify the correct stacking side.
 - If a sliding glass door opens on the right side (slides to the left), order a left stack.
 - If it opens on the left side (slides to the right), order a right stack.

Stackback

- Outside mounted shadings may be ordered so that the window opening is completely uncovered when the fabric is drawn open, as shown in the illustrations at the bottom of the page.
- Refer to the Stackback charts on page 63.
- Stackback is measured at the top of the shading.

Using the Stackback Charts

- Determine the desired uncovered width when the shading is drawn fully open.
 - With side stack designs, be sure to include in your uncovered width measurement the desired fabric overlap on the side opposite the fabric stack.
- Locate that width on the Stackback chart.
- Move across the row to find the correct ordered width.
- The Stackback dimension is shown in the column between the uncovered width and ordered width.
- Determine the desired uncovered width when the shading is drawn fully open.

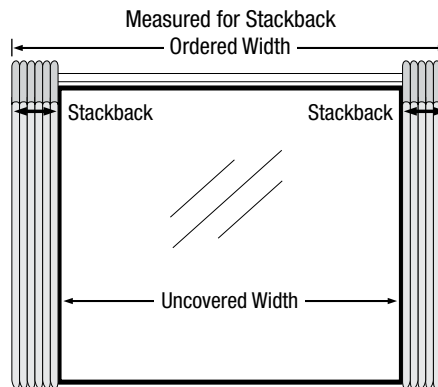
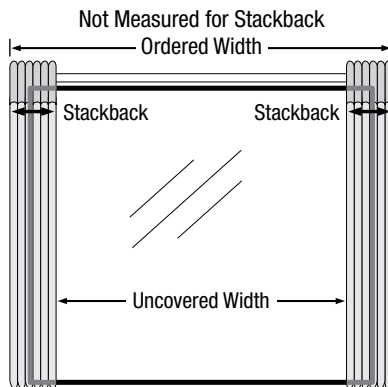
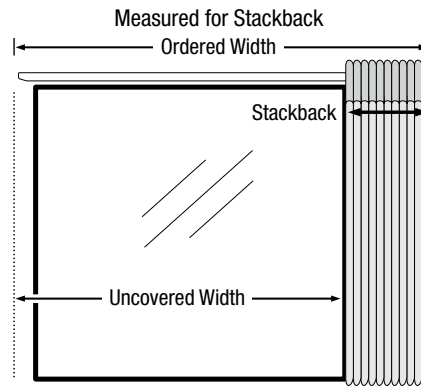
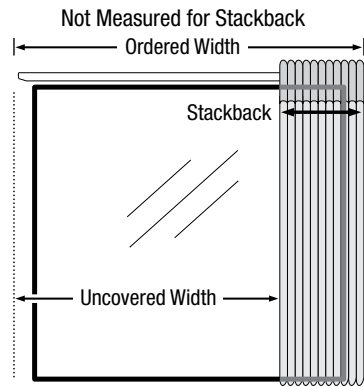

Stackback Charts

- The Stackback charts account for the typical stacking of the scissor track. As with any textile product, some variation is typical.
- On side stack shadings, include in your uncovered width measurement the desired amount of fabric overlap on the side opposite the fabric stack.
- Moving wand is not available in a split stack configuration.

OUTSIDE MOUNT

Side Stack		
Uncovered Width Up To	Stackback Up To	Ordered Width
5 ³ / ₈ "	7 ³ / ₈ "	12 ³ / ₄ "
7 ³ / ₄ "	7 ⁷ / ₈ "	15 ⁵ / ₈ "
10 ¹ / ₈ "	8 ³ / ₈ "	18 ¹ / ₂ "
12 ¹ / ₂ "	8 ⁷ / ₈ "	21 ³ / ₈ "
14 ⁷ / ₈ "	9 ³ / ₈ "	24 ¹ / ₄ "
17 ¹ / ₄ "	9 ⁷ / ₈ "	27 ¹ / ₈ "
19 ⁵ / ₈ "	10 ³ / ₈ "	30"
22"	10 ⁷ / ₈ "	32 ⁷ / ₈ "
24 ³ / ₈ "	11 ³ / ₈ "	35 ³ / ₄ "
26 ³ / ₄ "	11 ⁷ / ₈ "	38 ³ / ₈ "
29 ¹ / ₈ "	12 ³ / ₈ "	41 ¹ / ₂ "
31 ¹ / ₂ "	12 ⁷ / ₈ "	44 ³ / ₈ "
33 ³ / ₄ "	13 ³ / ₈ "	47 ¹ / ₈ "
36 ¹ / ₈ "	13 ⁷ / ₈ "	50"
38 ¹ / ₂ "	14 ³ / ₈ "	52 ⁷ / ₈ "
40 ⁷ / ₈ "	14 ⁷ / ₈ "	55 ³ / ₄ "
43 ¹ / ₄ "	15 ³ / ₈ "	58 ⁵ / ₈ "
45 ⁵ / ₈ "	15 ⁷ / ₈ "	61 ¹ / ₂ "
48"	16 ³ / ₈ "	64 ³ / ₈ "
50 ³ / ₈ "	16 ⁷ / ₈ "	67 ¹ / ₄ "
52 ³ / ₄ "	17 ³ / ₈ "	70 ¹ / ₈ "
55 ¹ / ₈ "	17 ⁷ / ₈ "	73"
57 ¹ / ₂ "	18 ³ / ₈ "	75 ⁷ / ₈ "
59 ⁷ / ₈ "	18 ⁷ / ₈ "	78 ³ / ₄ "
62 ¹ / ₈ "	19 ³ / ₈ "	81 ¹ / ₂ "
64 ¹ / ₂ "	19 ⁷ / ₈ "	84 ³ / ₈ "
66 ⁷ / ₈ "	20 ³ / ₈ "	87 ¹ / ₄ "
69 ¹ / ₄ "	20 ⁷ / ₈ "	90 ¹ / ₈ "
71 ⁵ / ₈ "	21 ³ / ₈ "	93"
74"	21 ⁷ / ₈ "	95 ⁷ / ₈ "
76 ³ / ₈ "	22 ³ / ₈ "	98 ³ / ₄ "
78 ³ / ₄ "	22 ⁷ / ₈ "	101 ⁵ / ₈ "
81 ¹ / ₈ "	23 ³ / ₈ "	104 ¹ / ₂ "
83 ¹ / ₂ "	23 ⁷ / ₈ "	107 ⁵ / ₈ "

Please Note:

- The maximum uncovered width of side stack sheers is 153¹/₈".
- Include in your uncovered width measurement the desired amount of fabric overlap on the side opposite the fabric stack.

Uncovered Width Up To	Stackback Up To	Ordered Width
85 ⁷ / ₈ "	24 ³ / ₈ "	110 ¹ / ₄ "
88 ¹ / ₄ "	24 ⁷ / ₈ "	113 ¹ / ₈ "
90 ⁵ / ₈ "	25 ³ / ₈ "	116"
92 ⁷ / ₈ "	25 ⁷ / ₈ "	118 ³ / ₄ "
95 ¹ / ₄ "	26 ³ / ₈ "	121 ⁵ / ₈ "
97 ⁵ / ₈ "	26 ⁷ / ₈ "	124 ¹ / ₂ "
100"	27 ³ / ₈ "	127 ³ / ₈ "
102 ³ / ₈ "	27 ⁷ / ₈ "	130 ¹ / ₄ "
104 ³ / ₄ "	28 ³ / ₈ "	133 ¹ / ₈ "
107 ¹ / ₈ "	28 ⁷ / ₈ "	136"
109 ¹ / ₂ "	29 ³ / ₈ "	138 ⁷ / ₈ "
111 ⁷ / ₈ "	29 ⁷ / ₈ "	141 ³ / ₄ "
114 ¹ / ₄ "	30 ³ / ₈ "	144 ⁵ / ₈ "
116 ⁵ / ₈ "	30 ⁷ / ₈ "	147 ¹ / ₂ "
119"	31 ³ / ₈ "	150 ³ / ₈ "
121 ¹ / ₄ "	31 ⁷ / ₈ "	153 ¹ / ₈ "
123 ⁵ / ₈ "	32 ³ / ₈ "	156"
126"	32 ⁷ / ₈ "	158 ⁷ / ₈ "
128 ³ / ₈ "	33 ³ / ₈ "	161 ³ / ₄ "
130 ³ / ₄ "	33 ⁷ / ₈ "	164 ⁵ / ₈ "
133 ¹ / ₈ "	34 ³ / ₈ "	167 ¹ / ₂ "
135 ¹ / ₂ "	34 ⁷ / ₈ "	170 ³ / ₈ "
137 ⁷ / ₈ "	35 ³ / ₈ "	173 ¹ / ₄ "
140 ¹ / ₄ "	35 ⁷ / ₈ "	176 ¹ / ₈ "
142 ⁵ / ₈ "	36 ³ / ₈ "	179"
145"	36 ⁷ / ₈ "	181 ⁷ / ₈ "
147 ³ / ₈ "	37 ³ / ₈ "	184 ³ / ₄ "
149 ³ / ₄ "	37 ⁷ / ₈ "	187 ⁵ / ₈ "
152"	38 ³ / ₈ "	190 ³ / ₈ "
153 ¹ / ₈ "	38 ⁷ / ₈ "	192"

Split Stack		
Uncovered Width Up To	Stackback Up To	Ordered Width
7 ³ / ₈ "	4 ¹ / ₂ " (x 2)	16 ³ / ₈ "
12 ¹ / ₈ "	5" (x 2)	22 ¹ / ₈ "
16 ⁷ / ₈ "	5 ¹ / ₂ " (x 2)	27 ⁷ / ₈ "
21 ⁵ / ₈ "	6" (x 2)	33 ⁵ / ₈ "
26 ³ / ₈ "	6 ¹ / ₂ " (x 2)	39 ³ / ₈ "
31"	7" (x 2)	45"
35 ³ / ₄ "	7 ¹ / ₂ " (x 2)	50 ³ / ₄ "
40 ¹ / ₂ "	8" (x 2)	56 ¹ / ₂ "
45 ¹ / ₄ "	8 ¹ / ₂ " (x 2)	62 ¹ / ₄ "
50"	9" (x 2)	68"
54 ³ / ₄ "	9 ¹ / ₂ " (x 2)	73 ³ / ₄ "
59 ¹ / ₂ "	10" (x 2)	79 ¹ / ₂ "
64 ¹ / ₈ "	10 ¹ / ₂ " (x 2)	85 ¹ / ₈ "
68 ⁷ / ₈ "	11" (x 2)	90 ⁷ / ₈ "
73 ⁵ / ₈ "	11 ¹ / ₂ " (x 2)	96 ⁵ / ₈ "
78 ³ / ₈ "	12" (x 2)	102 ³ / ₈ "
83 ¹ / ₈ "	12 ¹ / ₂ " (x 2)	108 ¹ / ₈ "
87 ⁷ / ₈ "	13" (x 2)	113 ⁷ / ₈ "
92 ¹ / ₂ "	13 ¹ / ₂ " (x 2)	119 ¹ / ₂ "
97 ¹ / ₄ "	14" (x 2)	125 ¹ / ₄ "
102"	14 ¹ / ₂ " (x 2)	131"
106 ³ / ₄ "	15" (x 2)	136 ³ / ₄ "
111 ¹ / ₂ "	15 ¹ / ₂ " (x 2)	142 ¹ / ₂ "
116 ¹ / ₄ "	16" (x 2)	148 ¹ / ₄ "
120 ⁷ / ₈ "	16 ¹ / ₂ " (x 2)	153 ⁷ / ₈ "
125 ⁵ / ₈ "	17" (x 2)	159 ⁵ / ₈ "
130 ³ / ₈ "	17 ¹ / ₂ " (x 2)	165 ³ / ₈ "
135 ¹ / ₈ "	18" (x 2)	171 ¹ / ₈ "
139 ⁷ / ₈ "	18 ¹ / ₂ " (x 2)	176 ⁷ / ₈ "
144 ⁵ / ₈ "	19" (x 2)	182 ⁵ / ₈ "
149 ¹ / ₄ "	19 ¹ / ₂ " (x 2)	188 ¹ / ₄ "
152"	20" (x 2)	192"

Please Note:

- The maximum uncovered width of split stack sheers is 152".
- Moving wand system is not available in a split stack configuration.

UV Protection

Ultraviolet light, entering the home as sunlight, damages furnishings. In time it fades wood floors, furniture, upholstery, draperies, carpeting and artwork. Prolonged exposure to sunlight causes natural, undyed fabrics to turn yellow, weakening their fibers and making them look old and worn prematurely.

The right window covering can be very effective in blocking ultraviolet rays. Such effectiveness is measured in terms of a "% UV blockage" rating. The higher the rating, the greater the UV protection.

Vertical Sheer Shading fabrics have the following UV Protection ratings:

Open Vanes	88
Closed Vanes	99

Cleaning and Care

The Vertical Sheer Shadings sheer, valance, and vane fabric are 100% polyester. They are resilient, anti-static, and dust resistant.

As part of the final step of installation, light steaming may be required. Steam the sheer so its contours are round, full and free of wrinkles; use short vertical strokes and steam from behind whenever possible.

Feather dusting or light vacuuming is usually all the customer needs to do to keep the sheer looking good.

Shadings can be spot cleaned any using a clothing pre-treatment solution. Blot the soiled area as you support it from behind with another cloth. Let dry, then blot with distilled or bottled water to rinse.

Ultrasonic Cleaning

For deep cleaning, both injection/extraction and ultrasonic cleaning methods are recommended for Vertical Sheer Shadings. Adco OnSite Fabricare provides shading and blind cleaning services. For more information, visit www.onsitefabricare.com. Comfortex acknowledges these cleaning methods as being safe and effective. We cannot attest to the quality of equipment or services provided by any independent cleaning facility.

For additional advice on care or cleaning, please contact the Comfortex Technical Service Department at 800-843-4151.

**Soft Tones & Vertical Sheer Shading
MEASURING INSTRUCTIONS**

Comfortex accepts measurements down to 1/16" increments.

Inside Mount

Use a steel tape to measure the opening at three different places, and use the narrowest dimension when ordering. Be exact! The factory will make the shade 3/8" narrower so it will not rub against the window casing. Measure the height of the window from the top (soffit) down to the sill.

Outside or Ceiling Mount

Use a steel tape to measure the exact height and width of the area to be covered. It is recommended that the shades overlap the window by at least 1 1/2" on each side. When installation has no sill, allow the shade to overlap the bottom of the window casing by at least 1 1/2". Shade fabric will measure width indicated on the order form.

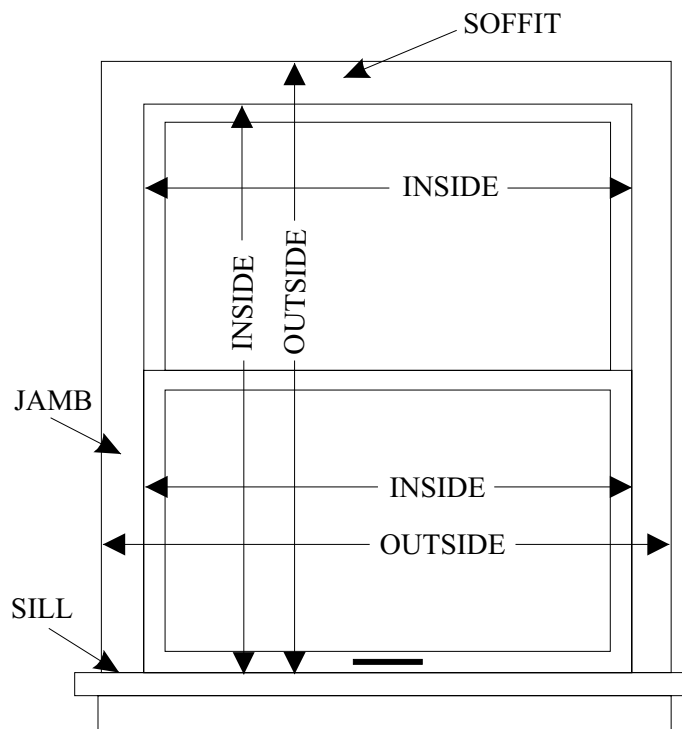

Paradise™ Sheer Shadings



Paradise™ Sheer Shadings Size Standards

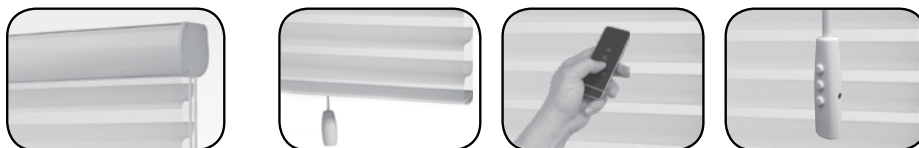

		Paradise Sheer Shading		Rechargeable Motorization	
		Cord Loop	Cordless	Simplicity	PowerTouch
LIGHT FILTERING ROOM DARKENING	Minimum Width	12"	18"	19"	21"
	Minimum Length	16"	16"	16"	16"

				Paradise Sheer Shading		Rechargeable Motorization	
				Cord Loop	Cordless	Simplicity	PowerTouch
Light Filtering	Price Group	Page	Maximum Width & Length	120"* x 120"	84"* x 84"	120"* x 102"	120"* x 102"
2½" Vanes	14	67					

				Paradise Sheer Shading		Rechargeable Motorization	
				Cord Loop	Cordless	Simplicity	PowerTouch
Room Darkening	Price Group	Page	Maximum Width & Length	120"* x 102"	84"* x 84"	120"* x 102"	120"* x 102"
2½" Vanes	15	67					

				Cord Loop	Cordless	Simplicity Rechargeable	PowerTouch Rechargeable
More Information On Page				Page 68	Page 73	Page 77	Page 75

Please Note: Once ordered and manufactured, the width of the Paradise fabric cannot be altered. Comfortex makes deductions to the width depending on the type of mounting indicated. For all mounting types, fabric will measure exactly the length ordered when the vanes are in the closed position.

* Head rail measurements include end caps.

Paradise Sheer Shadings Features At A Glance

- Paradise Sheer Shadings are a window shading of unique beauty and performance for the finishing touch to a beautiful window and room.
- Horizontal fabric vanes float between two layers of soft, knitted fabric sheers to soften your view outside.
- Features both light filtering and room darkening fabrics, these fabrics filter out up to 88% of harmful UV rays when open and 99% when closed.
- Paradise Sheer Shadings are the perfect way to provide the privacy and light control that any home needs.
- Vanes glide from open to closed to out of sight with elegant hardware.
- A weight system in the bottom rail allows for on-the-spot skew adjustment for proper performance and a balanced appearance in the window.
- The sophisticated array of Paradise Sheer Shadings colors is designed to flatter your decor.
- Easy to install hardware and brackets allow for effortless installations and easy removal for cleaning.
- Paradise Sheer Shadings may be ultrasonically or traditionally cleaned to stay bright and beautiful.
- A Limited Lifetime Warranty serves as a commitment to your satisfaction.

Paradise™ Sheer Shadings
2½" Light Filtering Vanes

PRICE GROUP 14
Cord Loop - Color Coordinated Rails

		Width In Inches												
		24	30	36	42	48	54	60	66	72	84	96	108	120
Length In Inches	36	545	611	684	747	819	889	955	1026	1201	1348	1486	1805	2125
	42	573	647	719	798	874	953	1026	1100	1281	1440	1589	1938	2286
	48	608	685	769	847	927	1011	1097	1183	1366	1532	1696	2075	2454
	54	632	718	806	896	986	1075	1170	1269	1450	1623	1815	2272	2728
	60	661	760	851	945	1039	1144	1243	1349	1526	1726	1933	2427	2921
	66	691	795	893	995	1100	1210	1327	1433	1608	1835	2057	2582	3105
	72	719	829	938	1045	1161	1281	1399	1518	1696	1938	2178	2751	3321
	78	741	858	972	1092	1214	1339	1461	1590	1777	2037	2286	2889	3490
	84	771	893	1012	1149	1275	1408	1544	1679	1868	2147	2411	3035	3663
	90	804	927	1058	1199	1337	1485	1618	1761	1958	2249	2530	3201	3873
	96	833	967	1103	1252	1399	1545	1691	1840	2049	2353	2651	3363	4074
	102	955	1105	1260	1424	1574	1717	1919	2105	2252	2562	2857	3455	4162
108	1007	1163	1327	1498	1653	1812	2017	2219	2373	2692	3009	3638	4267	
114	1067	1235	1406	1589	1761	1924	2139	2353	2517	2857	3190	3861	4532	
120	1149	1323	1510	1702	1877	2057	2287	2517	2693	3060	3414	4132	4845	

Paradise™ Sheer Shadings
2½" Room Darkening Vanes

PRICE GROUP 15
Cord Loop - Color Coordinated Rails

		Width In Inches												
		24	30	36	42	48	54	60	66	72	84	96	108	120
Length In Inches	36	600	672	752	822	900	978	1051	1128	1321	1482	1635	1985	2337
	42	630	712	792	878	960	1048	1128	1210	1410	1584	1748	2131	2515
	48	669	753	846	932	1021	1113	1207	1301	1503	1685	1866	2283	2699
	54	696	790	887	986	1085	1183	1287	1396	1595	1785	1997	2500	3002
	60	728	835	936	1039	1143	1259	1367	1483	1678	1899	2127	2670	3213
	66	761	875	982	1094	1210	1331	1459	1577	1769	2018	2263	2841	3416
	72	792	912	1032	1150	1277	1410	1539	1670	1866	2131	2395	3026	3654
	78	816	944	1069	1202	1335	1473	1607	1749	1955	2241	2515	3177	3839
	84	849	982	1114	1264	1402	1548	1698	1846	2056	2361	2652	3338	4029
	90	885	1021	1163	1319	1471	1634	1779	1936	2154	2474	2782	3521	4260
	96	917	1063	1214	1378	1539	1699	1860	2024	2254	2588	2916	3699	4482
	102	1051	1216	1386	1567	1732	1889	2110	2315	2478	2818	3142	3801	4578

Please Note: Room Darkening fabrics are not blackout fabrics. Knitted fabric may experience minor weave variations due to heat, humidity and other room conditions. These variations can result in light bowing, puckering and dimpling of the Paradise material. This is considered normal and does not constitute a failure in either workmanship or materials. The possible variations are minor and have been shown through case study not to detract from the beauty of the product.

LIFT SYSTEM AND DESIGN UPGRADES		ADD
Standard Rectangle	Coordinating Fabric Insert Strip For Head Rail	\$60

**Paradise™ Sheer Shadings
CORD LOOP HARDWARE SYSTEM**

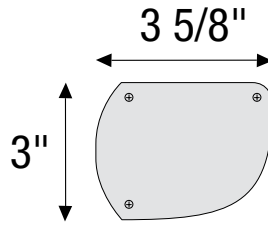

Cord Loop Rail Dimensions

- Depth of cassette: 3⁵/₈"
- Height of cassette: 3"

Hardware Features	
Hardware colors for all Paradise fabrics	Painted aluminum cassette head rail will be pre-coordinated to the fabric selection.
Cord	A nylon cord is standard.
Upgrades	
Head Rail Insert	Fabric head rail fabric inserts are optional. The color of the fabric insert coordinates with fabric used on the shading and is not necessarily an exact match to the vane material. See grids for surcharge information.

Mounting Dimensions	Cord Loop Hardware System
Minimum Depth Inside Mount	1 1/2"
Minimum Depth Flush Inside Mount	3 3/4"
Minimum Rear Fabric Clearance Inside Mount	1/8"
Minimum Surface Height Outside Mount	3 1/8"
Outside Mount Recommended Overlap Per Side	3"
Minimum Rear Fabric Clearance Outside Mount	1/8"

Finished Dimensions	
Inside Mount	
	<ul style="list-style-type: none"> • Fabric will measure ordered width less: 1" • Head rail* will measure ordered width less: 1/8"*
Outside Mount	
	<ul style="list-style-type: none"> • Fabric will measure ordered width minus: 3/4" • Head rail will measure ordered width • Fabric height will measure ordered length

* Head rail measurements include endcaps.

Please Note: Due to variations in fabric weave and environmental conditions, the finished dimensions for both width and length may vary, plus or minus 1/8" from your order measurements.

Paradise™ Sheer Shadings CORD LOOP HARDWARE SYSTEM

Applications

- Standard Rectangular

Cord Information

A nylon cord loop is used to raise and lower Paradise Sheer Shadings.

Select desired control side of the shade when ordering.

Shade Height	Loop Drop
16" to 19 ⁷ / ₈ "	12" loop
20" to 26 ⁷ / ₈ "	18" loop
27" to 39 ⁷ / ₈ "	24" loop
40" to 59 ⁷ / ₈ "	36" loop
60" to 83 ⁷ / ₈ "	48" loop
84" to 107 ⁷ / ₈ "	60" loop
108" to 120"	72" loop

Length Considerations

Paradise Sheer Shadings are fabricated to the exact length ordered, when the vanes are in the closed position (Figure A).

- When the vanes are rotated to the open position, the shading will become slightly longer.
- When opened on an inside mount, the shading will be slightly longer than ordered length.
- A slight puckering may occur when the vanes are in the open position. Rotating the vanes closed will cause the bottom rail to touch the window sill, before it begins to raise.

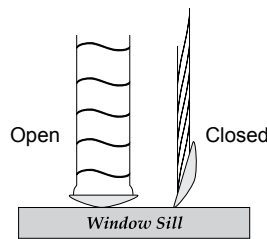

Figure A

Side By Side Alignment

When Paradise Sheer Shadings are installed side-by-side, vane alignment can be guaranteed within ¼" only if:

- The shadings are the same color and ordered at the same time.
- The sum total of the widths of all shadings needing alignment is less than 102".
- Side-by-side lineup is specified when the order is placed.

Vane Opening

Vane opening is the amount of unobstructed visibility between fully open vanes when looking through the shading at eye level. Vane opening for shadings is up to 1³/₈"

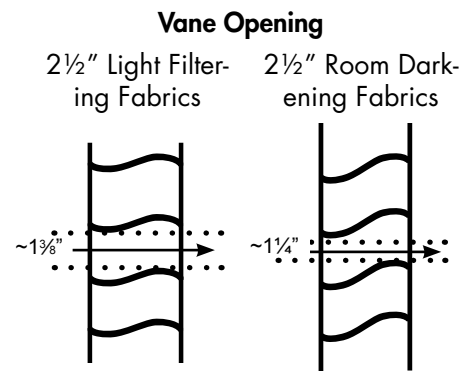

Vane Closure (Figure B)

Paradise vanes are not designed to close tightly. The inherent nature of the fabric will cause a slight increase in the distance from the front sheer to back sheer as you move further down the shading. These vanes do not form a perfect seal against light leakage which is most visible toward the bottom of the shading. Vane overlap ensures that privacy is not compromised.

Vane closure is measured as the distance between the front and rear fabric sheers 6" up from the lowest point of the bottom rail, with the shading fully lowered and the vanes closed.

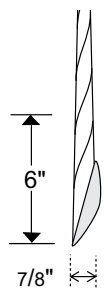

Figure B

On light filtering fabrics, the maximum distance from the front sheer to the back sheer when closed is equal to or less than 5/8" for shadings under 60" and 7/8" for shadings longer than 60". On room darkening fabrics, the distance is 5/8" regardless of shading length.

Paradise™ Sheer Shadings

CORD LOOP HARDWARE SYSTEM

Standard Operation

Refer to illustration below.

- Illustration 1: The shading is in the fully raised position.
- Illustration 2: Pull down on rear half of nylon cord loop to lower shading and open fabric vanes.
- Illustration 3: Pull down on front half of nylon cord loop to close vanes and raise shading

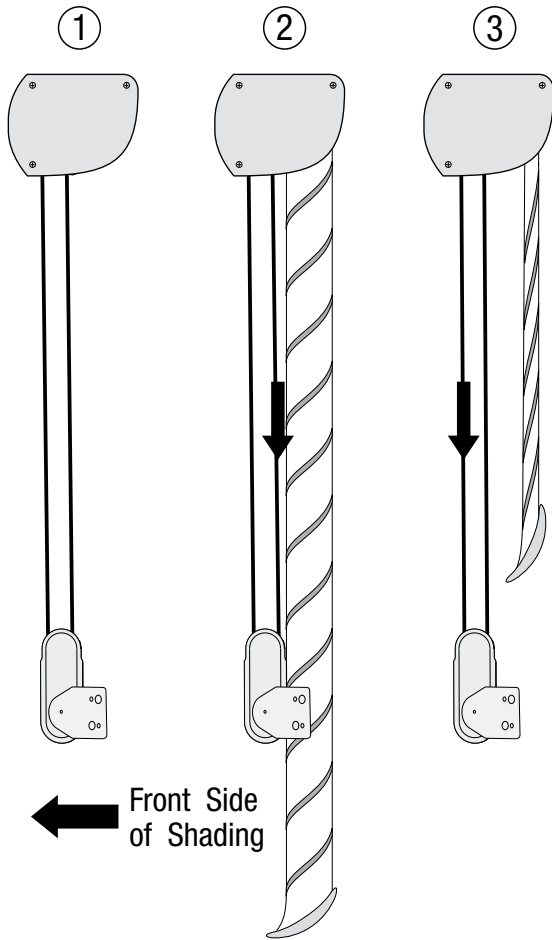

Light Control

With the shading in the fully lowered position, the nylon cord loop is used to adjust the fabric vanes from open to closed, and anywhere in between.

Please Note: The degree of maximum vane closure varies slightly from the top to the bottom of the shading.

Shading Adjustment

After installation, windows that are not square and level may cause the shadings to shift to one side as it rolls up, requiring adjustment of the bottom rail. If the brackets are not level it may be necessary to adjust the bottom rail weight.

- To access the bottom rail weight, release the weight clip on the bottom rail by using a flat blade screwdriver into the weight clip in the bottom rail and turn clockwise.
- Move the weight in 1" increments toward the side where the fabric is gathering.
- Secure the weight clips in position by turning them counterclockwise after making the adjustment.

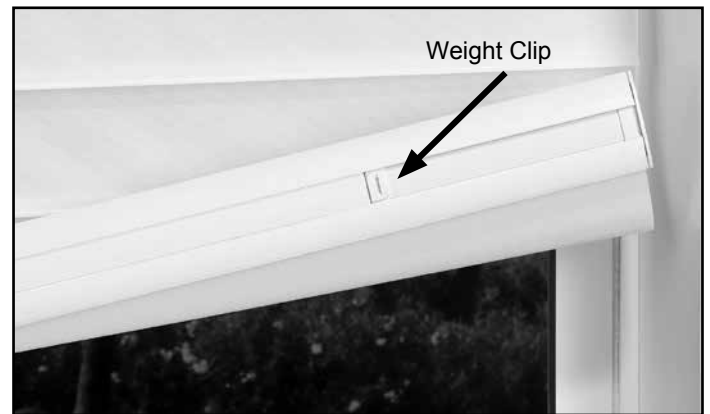

UV Protection

Ultraviolet light, entering the home as sunlight, damages furnishings. In time it fades wood floors, furniture, upholstery, draperies, carpeting and artwork. Prolonged exposure to sunlight causes natural, undyed fabrics to turn yellow, weakening their fibers and making them look old and worn prematurely.

The right window covering can be very effective in blocking ultraviolet rays. Such effectiveness is measured in terms of a "% UV blockage" rating. The higher the rating, the greater the UV protection.

Paradise Sheer Shadings fabrics have the following UV Protection ratings:

Light Filtering Fabrics	Open Vanes	88
Room Darkening Fabric	Open Vanes	88
All Fabrics	Closed Vanes	99

Paradise™ Sheer Shadings CORD LOOP HARDWARE SYSTEM

Magnetic Hold-Down Brackets

Optional magnetic hold-down brackets secure the bottom of the shading to prevent swaying. Please specify when ordering.

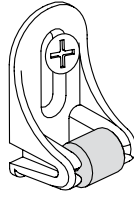

Extension Brackets

Extension or “L” brackets are available to project the back of the shading from the mounting surface. Those shading with metal roller system, it will project 2½”.

Spacer Blocks

Spacer blocks project the shading ¾” from the mounting surface. Use spacer blocks to obtain clearance when obstructions, such as window cranks or door handles, obstruct the movement of the shading.

Cleaning and Care

Paradise Sheer Shadings are made from a sturdy, knitted polyester fabric which can be feather dusted or vacuumed at a low setting. Spots or stains can be lightly rubbed clean with a damp sponge and mild soap. To avoid discoloration of the material, we recommend against the use of chemical cleaners.

Precautions should be taken to reduce exposure to harsh environmental elements, such as salt air. Continuous exposure to salt air through open windows and doors will accelerate fabric deterioration over time.

Important: Do not clean the fabric using electrostatic wipes such as Swiffer® or Pledge Grab-It®.

Ultrasonic Cleaning

Paradise Sheer Shadings can be ultrasonically cleaned. Adco OnSite Fabricare provides shading and blind cleaning services. For more information, visit www.AdcoOnSite.com. Comfortex acknowledges these cleaning methods as being safe and effective. We cannot attest to the quality of equipment or services provided by any independent cleaning facility.

For additional advice on care or cleaning, please contact the Comfortex Technical Service Department at 800-843-4151.

Measuring Instructions

See page 93 for measuring instructions.

Child Safety

See page 94 for child safety information.

Limited Lifetime Warranty

See page 96 for warranty information.

Paradise™ Sheer Shadings DETAILED VIEW

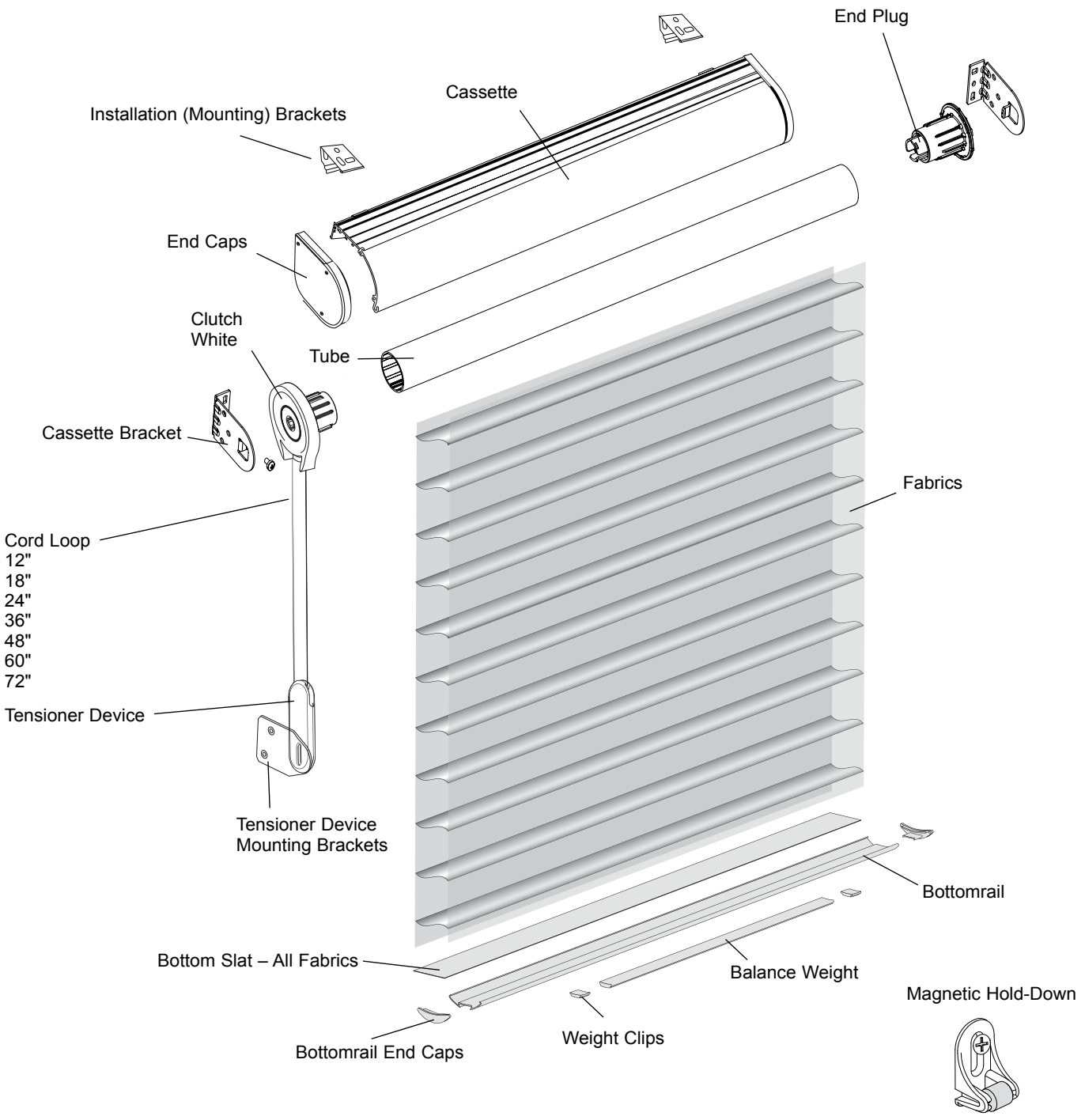

Paradise™ Sheer Shadings CORDLESS HARDWARE SYSTEM

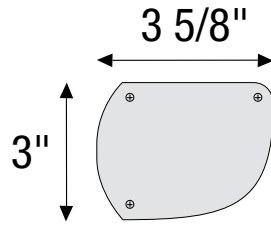
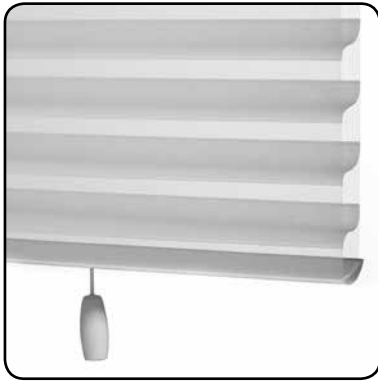

Cord Loop Rail Dimensions

- Depth of cassette: 3 5/8"
- Height of cassette: 3"

Hardware Features	
Hardware colors for all Paradise fabrics	Painted aluminum cassette head rail will be pre-coordinated to the fabric selection.
Tassel	Cord and tassel coordinates with your hardware color.
Upgrades	
Head Rail Insert	Fabric head rail fabric inserts are optional. The color of the fabric insert coordinates with fabric used on the shading and is not necessarily an exact match to the vane material. See grids for surcharge information.
Mounting Dimensions	
Cordless Hardware System	
Minimum Depth Inside Mount	1 1/2"
Minimum Depth Flush Inside Mount	3 3/4"
Minimum Rear Fabric Clearance Inside Mount	1/8"
Minimum Surface Height Outside Mount	3 1/8"
Outside Mount Recommended Overlap Per Side	3"
Minimum Rear Fabric Clearance Outside Mount	1/8"
Finished Dimensions	
Inside Mount	
	<ul style="list-style-type: none"> • Fabric will measure ordered width less: 1" • Head rail* will measure ordered width less: 1/8"*
Outside Mount	
	<ul style="list-style-type: none"> • Fabric will measure ordered width minus: 3/4" • Head rail will measure ordered width • Fabric height will measure ordered length
* Head rail measurements include endcaps.	
Please Note: Due to variations in fabric weave and environmental conditions, the finished dimensions for both width and length may vary, plus or minus 1/8" from your order measurements.	

Paradise™ Sheer Shadings CORDLESS HARDWARE SYSTEM

Applications

- Standard Rectangular

Length Considerations

Paradise Sheer Shadings are fabricated to the exact length ordered, when the vanes are in the closed position (Figure A).

- When the vanes are rotated to the open position, the shading will become slightly longer.
- When opened on an inside mount, the shading will be slightly longer than ordered length.
- A slight puckering may occur when the vanes are in the open position. Rotating the vanes closed will cause the bottom rail to touch the window sill, before it begins to raise.

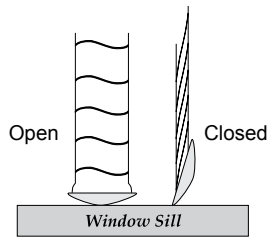

Figure A

Side By Side Alignment

When Paradise Sheer Shadings are installed side-by-side, vane alignment can be guaranteed within 1/4" only if:

- The shadings are the same color and ordered at the same time.
- The sum total of the widths of all shadings needing alignment is less than 102".
- Side-by-side lineup is specified when the order is placed.

Vane Opening

Vane opening is the amount of unobstructed visibility between fully open vanes when looking through the shading at eye level. Vane opening for shadings is up to 1 3/8"

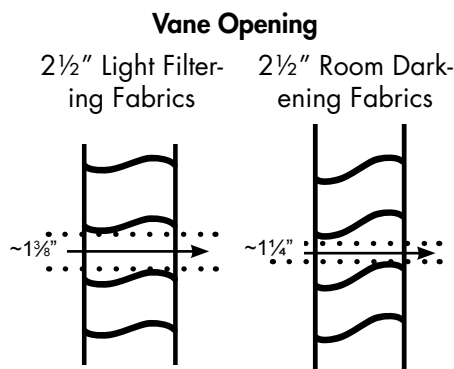

Vane Closure (Figure B)

Paradise vanes are not designed to close tightly. The inherent nature of the fabric will cause a slight increase in the distance from the front sheer to back sheer as you move further down the shading. These vanes do not form a perfect seal against light leakage which is most visible toward the bottom of the shading. Vane overlap ensures that privacy is not compromised.

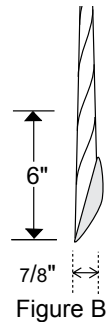

Figure B

Vane closure is measured as the distance between the front and rear fabric sheers 6" up from the lowest point of the bottom rail, with the shading fully lowered and the vanes closed.

On light filtering fabrics, the maximum distance from the front sheer to the back sheer when closed is equal to or less than 5/8" for shadings under 60" and 7/8" for shadings longer than 60". On room darkening fabrics, the distance is 5/8" regardless of shading length.



Cordless Tassel with Vanes Closed



Cordless Tassel with Vanes Opened

To Lower Cordless Paradise Shading

Pull down on the tassel until the shade is at the desired height.

To Raise Cordless Paradise Shading

Gently pull down on the tassel. To raise the shade completely, simply release the tassel and the shade will roll up fully into the headrail. To raise the shade partially, when the shade is at the desired height, gently pull on the tassel to stop the shade from raising.

Paradise™ Sheer Shadings Hardware Options

POWERTOUCH RECHARGEABLE | DESIGNER CASSETTE HEAD RAIL

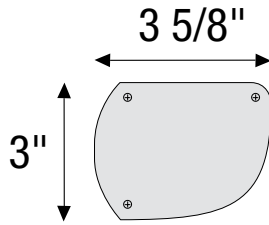

Cord Loop Rail Dimensions

- Depth of cassette: 3 5/8"
- Height of cassette: 3"

Hardware Features	
Standard Designer Cassette	Choose from coordinating Fabric Insert or painted Smooth Face rail. Painted aluminum cassette head rail will be pre-coordinated to the fabric selection.
Bottom Rail Color	Color coordinated rail.
Upgrades	
Head Rail Insert	Fabric head rail fabric inserts are optional. The color of the fabric insert coordinates with fabric used on the shading and is not necessarily an exact match to the vane material. See grids for surcharge information.

Mounting Dimensions	PowerTouch Hardware System
Minimum Depth Inside Mount	1 1/2"
Minimum Depth Flush Inside Mount	3 3/4"
Minimum Rear Fabric Clearance Inside Mount	1/8"
Minimum Surface Height Outside Mount	3 1/8"
Outside Mount Recommended Overlap Per Side	3"
Minimum Rear Fabric Clearance Outside Mount	1/8"

Finished Dimensions	
Inside Mount	
	<ul style="list-style-type: none"> • Fabric will measure ordered width less: 1" • Head rail* will measure ordered width less: 1/8"*
Outside Mount	
	<ul style="list-style-type: none"> • Fabric will measure ordered width minus: 3/4" • Head rail will measure ordered width • Fabric height will measure ordered length

* Head rail measurements include endcaps.

Please Note: Due to variations in fabric weave and environmental conditions, the finished dimensions for both width and length may vary, plus or minus 1/8" from your order measurements.

Paradise™ Sheer Shadings

POWERTOCH RECHARGEABLE | DESIGNER CASSETTE HEAD RAIL

PowerTouch™ Rechargeable Shades

Paradise Shadings can be fabricated with the PowerTouch Rechargeable Push Button Control option. The PowerTouch Rechargeable option is an easy, cord free motorized operation for the budget savvy homeowner. PowerTouch Rechargeable uses Simplicity motors and components.

PowerTouch Rechargeable Shades Operation

Press the up or down button on the pendant to raise or lower the shading to your desired position.

No programming is required with PowerTouch™, all programming is set at the factory. Upper and lower limits easily can be adjusted in the field if desired. Favorites position can be programmed on-site. Please refer to the installation instructions at comfortex.com/comfortex-dealers.

PowerTouch Rechargeable Surcharges

See page 8.

PowerTouch Appearance

- The PowerTouch Rechargeable wand and pendant is attached to the head rail and requires no additional mounting.
- The wand and pendant hangs down the front of the shades from the head rail. The wand does not touch the fabric.
- Pendant is 2½" long.



PowerTouch Rechargeable Color Options

- Shadings with Black or Oil Rubbed Bronze hardware will be built with black wand and pendants standard. All other colors will use white wand and pendants.



White



Black Shown with Plug-In Charger

PowerTouch Wand and Pendant Location

The standard location for the wand and pendant is on the right. Please specify location when ordering.

PowerTouch Rechargeable Wand Length

Size and color must be specified when ordered. Below is a recommended size chart.

Shading Length	Standard Wand Length
Up to 30"	1' (12")
>30" to 52"	2' (24")
>52" to 78"	3' (36")
>78" to 100"	4' (48")
>100" to 120"	5' (60")

- Wand length is in 1 foot increments. 1 foot - 5 foot

Mounting Requirements for PowerTouch Rechargeable Shadings

- No special installation hardware or wiring requirements are needed.
- The wand and pendant do not need to be mounted to operate the shading.

PowerTouch Rechargeable Battery Life

The battery life will vary based on the type of window covering selected, the size and weight of the window covering and the number of times you operate the blind on a daily basis.

Battery Charger

8.4 Volt charger requires a standard power outlet to recharge the battery. Must specify charger when ordering a Simplicity PowerTouch Rechargeable Shading. The charger plugs into the charger port. The charger is black and comes with a 156" wire. The dimensions are 1" wide x 2½" length x 1¼" deep.



PowerTouch Rechargeable Shadings Warranty

Please see page 95 for complete warranty information.

Paradise™ Sheer Shadings Hardware Options

SIMPLICITY INTEGRATED RECHARGEABLE MOTORIZATION

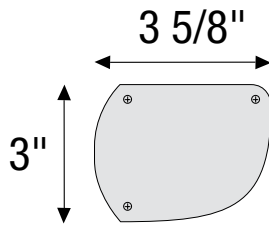

Cord Loop Rail Dimensions

- Depth of cassette: 3 5/8"
- Height of cassette: 3"

Hardware Features	
Hardware colors for all Paradise fabrics	Painted aluminum cassette head rail will be pre-coordinated to the fabric selection.
Cord	A nylon cord is standard.
Upgrades	
Head Rail Insert	Fabric head rail fabric inserts are optional. The color of the fabric insert coordinates with fabric used on the shading and is not necessarily an exact match to the vane material. See grids for surcharge information.
Mounting Dimensions	
Simplicity Integrated Rechargeable Hardware System	
Minimum Depth Inside Mount	1 1/2"
Minimum Depth Flush Inside Mount	3 3/4"
Minimum Rear Fabric Clearance Inside Mount	1/8"
Minimum Surface Height Outside Mount	3 1/8"
Outside Mount Recommended Overlap Per Side	3"
Minimum Rear Fabric Clearance Outside Mount	1/8"
Finished Dimensions	
Inside Mount	
	<ul style="list-style-type: none"> • Fabric will measure ordered width less: 1" • Head rail* will measure ordered width less: 1/8"*
Outside Mount	
	<ul style="list-style-type: none"> • Fabric will measure ordered width minus: 3/4" • Head rail will measure ordered width • Fabric height will measure ordered length
* Head rail measurements include endcaps.	
Please Note: Due to variations in fabric weave and environmental conditions, the finished dimensions for both width and length may vary, plus or minus 1/8" from your order measurements.	

Paradise™ Sheer Shadings

SIMPLICITY INTEGRATED RECHARGEABLE MOTORIZATION HEAD RAIL

Simplicity Rechargeable Motors

The Rechargeable Simplicity Motor program features an integrated rechargeable lithium ion battery in the motor casing and is fully concealed by the roller tube.

PowerTouch Integrated Rechargeable Surcharges

See page 66 for shading standards and page 8 for surcharges and pricing example.

Simplicity Rechargeable Motors

No special installation hardware or wiring requirements are needed to install motorized Shangri-La Shadings with Designer Cassette Head Rail. No external battery wand is required. See page 44 for mounting information.

Rechargeable Simplicity Motor Batteries

The battery for the integrated rechargeable simplicity motor system is integrated within the motor casing and is fully concealed by the roller tube.

Rechargeable battery comes fully charged from the factory.

Integrated Rechargeable Motor Battery Life

Rechargeable battery is included with the motor.

The average battery charge will last 6-12 months based on an average sized shade raised and lowered once per day. The life of the battery charge will vary based on the type of window covering selected, the size and weight of the window covering and the number of times the shade is operated on a daily basis.

The battery can be recharged up to 500 times. It takes approximately 5 hours to recharge the motor when fully depleted.

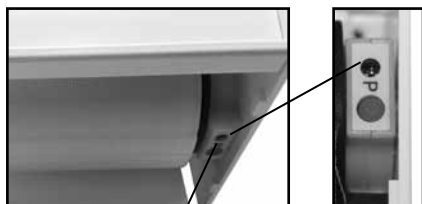

Charging Port

Close-Up

Integrated Rechargeable Motor Battery Charger

An 8.4 Volt charger requires a standard power outlet to recharge the battery. The charger must be specified when ordering an Integrated Rechargeable Simplicity Motorized shade. The charger plugs into the charging port of the motor. Required with Integrated Shading order. Sold separately.



The charger is black and comes with a 156" wire. The dimensions are 1" wide x 2½" length x 1¾" deep.

Simplicity Motor Hand Held Remotes

IMPORTANT: Simplicity Rechargeable Motorized Shadings are programmed at the factory with the "up and down" limits. The shades are **UNLINKED** from the remote so they are not able to operate during shipping. Each shade should be installed **before** linking it to the remote.

5 Channel Remote

The **5 Channel (5C) remote** can operate up to five shadings simultaneously, individually or in groups.

Simplicity (5C) remotes and holders are black in color. The remote comes with a holder which can be mounted to a wall for easy storage. The range of the remote is approximately 80 feet.



Please Note:

- Not all motors run at the same rate of speed.
- Simplicity motors have a "Favorites" or "MY" position setting. If the homeowner wants to set several shadings at the same intermediate position, follow instructions provided with installation manual.
- **WHEN ORDERING THE NEW INTEGRATED RECHARGEABLE, PLEASE ORDER THE NECESSARY BATTERY CHARGER.** e information.

Solar Panel Recharge Option

Plugs in to any Simplicity Rechargeable Remote control shade (does not work with PowerTouch).

See page 32.



Dimensions of panel
18½" x 1½"

Paradise™ Sheer Shadings SIMPLICITY INTEGRATED RECHARGEABLE MOTORIZATION

Important Information about Integrated Rechargeable Simplicity Motor Shading Operation and Installation

- Simplicity Motorized Shadings installed into windows with metal casings may have a reduced radio frequency range, or may not operate at all, depending on control.
- Be mindful of when your shade starts to slow down during operation. It is a good indicator the shade needs to be recharged.



Overtones™ Sheer Shades



Overtones™ Sheer Shades Fabric Specifications

Pattern Name	Color Band Height	Sheer Band Height	Opacities	Fabric Composition
Ambrosia	4"	~2"	• Room Darkening	• 100% Polyester
Band	2¾"	~2"	• Translucent	• 100% Polyester
Barnegat	3"	~2"	• Translucent	• 100% Polyester
Bistro	2¾"	~2"	• Translucent	• 85% Polyester/15% Linen
Boutique	3"	~2"	• Translucent	• 100% Polyester
Duotone	2⅞"	~2"	• Translucent	• 100% Woven Polyester
Focus	3"	~2"	• Translucent	• 100% Polyester
Galaxy	3"	~2"	• Translucent	• 100% Polyester
Journey	3"	~2"	• Translucent	• 100% Polyester
Modish	3"	~2"	• Room Darkening	• 100% Polyester
Orion	5½"	~2"	• Translucent	• 100% Polyester
Piquant	2¾"	~2"	• Translucent	• 100% Polyester
Silver Lining	3"	~2"	• Translucent	• 100% Polyester



Overtone™ Sheer Shades Size Standards

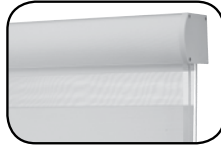

				Overtone Sheer Shades			Rechargeable Motorization								
				Cord Loop			Simplicity			PowerTouch					
ALL FABRICS				Minimum Width			15"			19"			21"		
				Minimum Length			24"			20"			20"		
				Overtone Sheer Shades			Rechargeable Motorization								
				Cord Loop			Simplicity			PowerTouch					
Translucent	Price Group	Page	Maximum	Cord Loop			Simplicity			PowerTouch					
Focus	18	83	Width & Length	100" x 100"			100" x 100"			100" x 100"					
Piquant	17	83		100" x 120"			100" x 120"			100" x 120"					
Bistro	18	83		92" x 120"			92" x 120"			92" x 120"					
Duotone	19	84		94" x 120"			94" x 120"			94" x 120"					
Barnegat	16	83		96" x 120"			96" x 120"			96" x 120"					
Band	17	83		100" x 120"			100" x 120"			100" x 120"					
Boutique	17	83													
Galaxy	19	84													
Journey	18	83													
Orion	19	84													
Silver Lining	18	83													
				Overtone Sheer Shades			Rechargeable Motorization								
				Cord Loop			Simplicity			PowerTouch					
Room Darkening	Price Group	Page	Maximum	Cord Loop			Simplicity			PowerTouch					
Ambrosia	20	84	Width & Length	96" x 100"			96" x 100"			96" x 100"					
Modish	20	84		90" x 120"			90" x 120"			90" x 120"					
				Overtone Sheer Shades			Motorization								
More Information On Page				Page 85			Page 88-92								

Overtone Sheer Shades Features At A Glance

The Overtone Sheer Shades are a window shading of unique beauty and performance. The dual panels, with alternating horizontal solid and sheer vanes, add the perfect finishing touch for beautiful luminous windows.

- Overtone Sheer Shades incorporate dual layers of alternating solid and sheer horizontal vanes that can "open and close".
- In the closed position, the fabric allows softly diffused light and offers full privacy.
- In the open position, the vanes are aligned and light filters through the sheers for gentle illumination.
- The Overtone panels can be raised up and out of sight into the integrated valance.
- The head rail has a matching fabric insert strip and color coordinated cord loop mechanism.
- Overtone Shades are available to widths of 100" and drops to 120" (fabric dependent) to provide visual elegance to wide windows and doors.
- A Limited Lifetime Warranty serves as a commitment to your satisfaction.

Barneгат 3" Translucent Vanes

PRICE GROUP 16
Cord Loop - Color Coordinated Rails

		Width In Inches													
		24	30	36	42	48	54	60	66	72	78	84	90	96	100
Length In Inches	40	373	414	461	500	540	581	629	669	719	772	806	846	929	956
	50	384	431	479	524	566	610	661	706	758	815	852	894	982	1009
	60	397	446	499	544	592	640	694	742	798	857	898	944	1034	1065
	70	410	463	518	568	618	669	727	777	838	899	943	994	1086	1119
	80	423	478	537	591	646	699	761	814	877	943	989	1042	1141	1175
	90	436	495	557	614	671	729	793	849	916	986	1035	1092	1191	1229
	100	449	511	576	637	698	758	826	885	956	1028	1083	1142	1245	1284
	110	463	527	596	659	723	787	859	922	995	1070	1127	1189	1297	1339
	120	474	543	616	682	749	816	891	957	1034	1113	1174	1240	1350	1393

Band 2¾" Translucent Vanes
Piquant 2¾" Translucent Vanes

PRICE GROUP 17
Cord Loop - Color Coordinated Rails

		Width In Inches													
		24	30	36	42	48	54	60	66	72	78	84	90	96	100
Length In Inches	40	502	564	629	688	749	809	879	937	1008	1084	1135	1193	1308	1347
	50	525	592	664	730	795	861	937	1001	1080	1160	1217	1282	1401	1445
	60	546	621	699	771	842	913	996	1066	1150	1238	1301	1371	1497	1543
	70	570	650	733	810	890	967	1054	1130	1220	1313	1383	1458	1591	1643
	80	594	680	770	852	936	1021	1113	1195	1292	1391	1465	1548	1687	1740
	90	617	708	804	893	983	1071	1173	1261	1362	1466	1547	1636	1780	1839
	100	640	738	839	935	1031	1125	1232	1325	1432	1543	1631	1726	1875	1939
	110	662	765	874	974	1077	1179	1290	1389	1504	1620	1713	1813	1970	2036
	120	685	794	909	1015	1123	1232	1349	1453	1574	1696	1796	1902	2063	2134

Bistro 2¾" Translucent Vanes
Boutique 3" Translucent Vanes
Focus 3" Translucent Vanes
Journey 3" Translucent Vanes
Silver Lining 3" Translucent Vanes

PRICE GROUP 18
Cord Loop - Color Coordinated Rails

		Width In Inches													
		24	30	36	42	48	54	60	66	72	78	84	90	96	100
Length In Inches	40	520	588	658	722	787	852	926	989	1066	1147	1203	1266	1385	1426
	50	546	621	699	770	841	913	995	1065	1149	1235	1299	1368	1495	1542
	60	574	654	740	817	896	975	1063	1142	1232	1325	1395	1473	1605	1658
	70	600	687	780	865	951	1035	1131	1215	1313	1415	1491	1575	1716	1772
	80	627	722	821	912	1006	1098	1201	1292	1397	1505	1588	1680	1826	1888
	90	654	756	861	960	1060	1159	1269	1367	1479	1594	1685	1784	1938	2003
	100	681	790	904	1008	1116	1221	1337	1444	1563	1683	1783	1888	2048	2119
	110	708	823	943	1057	1170	1283	1407	1519	1645	1773	1877	1991	2158	2234
	120	736	857	984	1104	1225	1343	1476	1595	1727	1862	1974	2094	2269	2348

Duotone 2⁷/₈" Translucent Vanes
Galaxy 3" Translucent Vanes
Orion 5¹/₂" Translucent Vanes

PRICE GROUP 19
Cord Loop - Color Coordinated Rails

		Width In Inches													
		24	30	36	42	48	54	60	66	72	78	84	90	96	100
Length In Inches	40	560	635	718	793	867	943	1028	1101	1188	1278	1346	1419	1548	1598
	50	595	680	771	854	939	1023	1117	1201	1297	1395	1472	1554	1693	1748
	60	629	725	825	917	1009	1104	1207	1299	1404	1513	1598	1690	1836	1899
	70	664	769	878	979	1083	1183	1297	1397	1513	1630	1723	1825	1982	2048
	80	699	814	930	1042	1154	1265	1387	1497	1620	1748	1851	1961	2126	2200
	90	733	857	984	1104	1225	1346	1476	1595	1728	1863	1977	2096	2272	2350
	100	770	900	1038	1167	1297	1426	1567	1695	1836	1982	2102	2232	2416	2501
	110	804	944	1091	1229	1368	1508	1656	1794	1945	2099	2228	2368	2561	2652
	120	839	989	1144	1291	1440	1587	1746	1892	2053	2216	2355	2503	2704	2802

Ambrosia 4" Room Darkening Vanes
Modish 3" Room Darkening Vane

PRICE GROUP 20
Cord Loop - Color Coordinated Rails

		Width In Inches													
		24	30	36	42	48	54	60	66	72	78	84	90	96	100
Length In Inches	40	584	666	752	834	915	996	1087	1167	1261	1357	1429	1509	1644	1697
	50	622	716	814	905	996	1087	1188	1278	1383	1489	1573	1663	1809	1869
	60	661	765	874	975	1078	1180	1292	1392	1507	1624	1717	1817	1973	2041
	70	701	816	935	1046	1159	1271	1393	1505	1629	1757	1860	1972	2137	2212
	80	742	866	996	1118	1240	1363	1496	1617	1752	1890	2004	2126	2304	2384
	90	781	916	1057	1188	1322	1455	1598	1729	1875	2023	2148	2280	2466	2555
	100	822	968	1117	1260	1403	1547	1701	1843	1999	2157	2291	2434	2632	2728
	110	861	1016	1177	1330	1484	1638	1802	1954	2122	2290	2435	2589	2797	2898
	120	900	1066	1238	1400	1566	1729	1905	2068	2244	2423	2580	2743	2961	3070

Product Attributes: Environmental condition, such as heat, humidity, etc. may result in light bowing, puckering and dimpling of the fabric which is considered normal. Some fabrics may lightly fray which is considered normal and within specifications.

Overtones™ Sheer Shades CORD LOOP HARDWARE SYSTEM

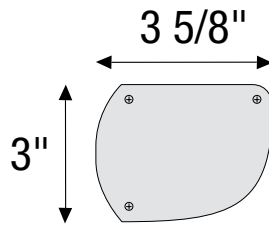

Cord Loop Rail Dimensions

- Depth of cassette: 3 5/8"
- Height of cassette: 3"

Hardware Features	
Hardware colors for all Overtones fabrics	Integrated cassette head rail and bottom rail will be pre-coordinated to the fabric selection. Matching fabric insert is standard. Fabric wrapped bottom rail is standard.
Cord Loop	Cord color will coordinate with your shade fabric.
Mounting Dimensions	
Minimum Depth Inside Mount (shallow mount)	1 1/2"
Minimum Depth Flush Inside Mount including brackets	3 3/4"
Minimum Surface Outside Mount	1 1/2"
Finished Dimensions	
Inside Mount	
	<ul style="list-style-type: none"> • Fabric will measure ordered width less: 1 1/4" • Fabric will measure ordered length • Head rail* will measure ordered width less: 1/4"* • Tube will measure ordered width less: 1 1/8" • Bottom rail outer width will measure ordered width less: 1 3/16" • Bottom rail inner width will measure ordered width less: 1 3/8"
Outside Mount	
	<ul style="list-style-type: none"> • Fabric will measure ordered width less: 1" • Fabric will measure ordered length • Head rail will measure ordered width • Tube will measure ordered width less: 7/8" • Bottom rail outer width will measure ordered width less: 15/16" • Bottom rail inner width will measure ordered width less: 1 1/8"
	<p>* Head rail measurements includes plastic endcaps.</p> <p>Length Considerations: Comfortex will fabricate your Overtones Sheer Shades to the exact length ordered, plus or minus 1/8". The vanes will be in the closed position when the shade is at its full ordered length as seen in Figure B on page 16.</p>

Information for Ordering

- Follow basic measuring instructions
- Specify left or right cord loop
- Extension brackets and spacers are available at no extra charge
- Specify hold down brackets if required
- Side mount brackets are NOT available

Measuring Instructions

See page 93 for measuring instructions.

Child Safety

See page 94 for child safety information.

Limited Lifetime Warranty

See page 96 for warranty information.

Applications

- Standard Rectangular

Overtones Sheer Shades Specifications

Once ordered and manufactured, the width of the Overtones fabric cannot be altered. Comfortex makes deductions to the width of Overtones Sheer Shades depending on the type of mounting indicated. For all mounting types, the fabric will measure exactly the length ordered when the shade is fully lowered and the vanes are in the closed position.

Loop Cord Information

Overtones Sheer Shades utilize a looped cord to operate the shade. The cord color will coordinate with your shade fabric. The cord loops will measure the length indicated below from 2 feet to 8 feet at 1 foot intervals unless otherwise specified.

Shade Height	Standard Loop
24" to 39 ⁷ / ₈ "	2' (24")
40" to 59 ⁷ / ₈ "	3' (36")
60" to 83 ⁷ / ₈ "	4' (48")
84" to 107 ⁷ / ₈ "	5' (60")
108" to 120"	6' (72")

Side By Side Alignment

When Overtones Sheer Shades are installed side-by-side, vane alignment can be guaranteed within 1/4" only if:

- The shades are the same color and ordered at the same time.
- The sum total of the widths of all shades needing alignment is less than the maximum shade width of the fabric style ordered. See page 82.
- Side-by-side lineup is specified when the order is placed.

Cleaning and Care of Overtones Fabrics

Overtones fabric is made from a sturdy, woven polyester fabric which can be feather dusted or vacuumed at a low setting. Spots or stains can be lightly rubbed clean with a damp sponge and mild soap. To avoid discoloration of the material, we recommend against the use of chemical cleaners.

For additional care and cleaning information, please contact the Comfortex Technical Services Department at 800-843-4151.

Operation

Overtones Sheer Shades incorporate dual layers of alternating solid and sheer horizontal vanes. By aligning the sheer or the solid portion of the fabric, you can control the amount of light that enters the room.



Figure A

The dual layers of solid and sheer horizontal vanes continually cross over each other as the shade is raised or lowered. This allows users to control the amount of incoming light and the view-through effect with the shade partially raised at various points throughout the window as seen in Figure A.



Figure B

When the Overtones Shade is fully lowered, the vanes are overlapped.

When in the closed position, Overtones fabric diffuses incoming light, providing a warm glow. The vanes will be in the closed position when the shade is at its full ordered length as seen in Figure B.

Overtones™ Sheer Shades

DETAILED VIEW

Overtones Sheer Shades

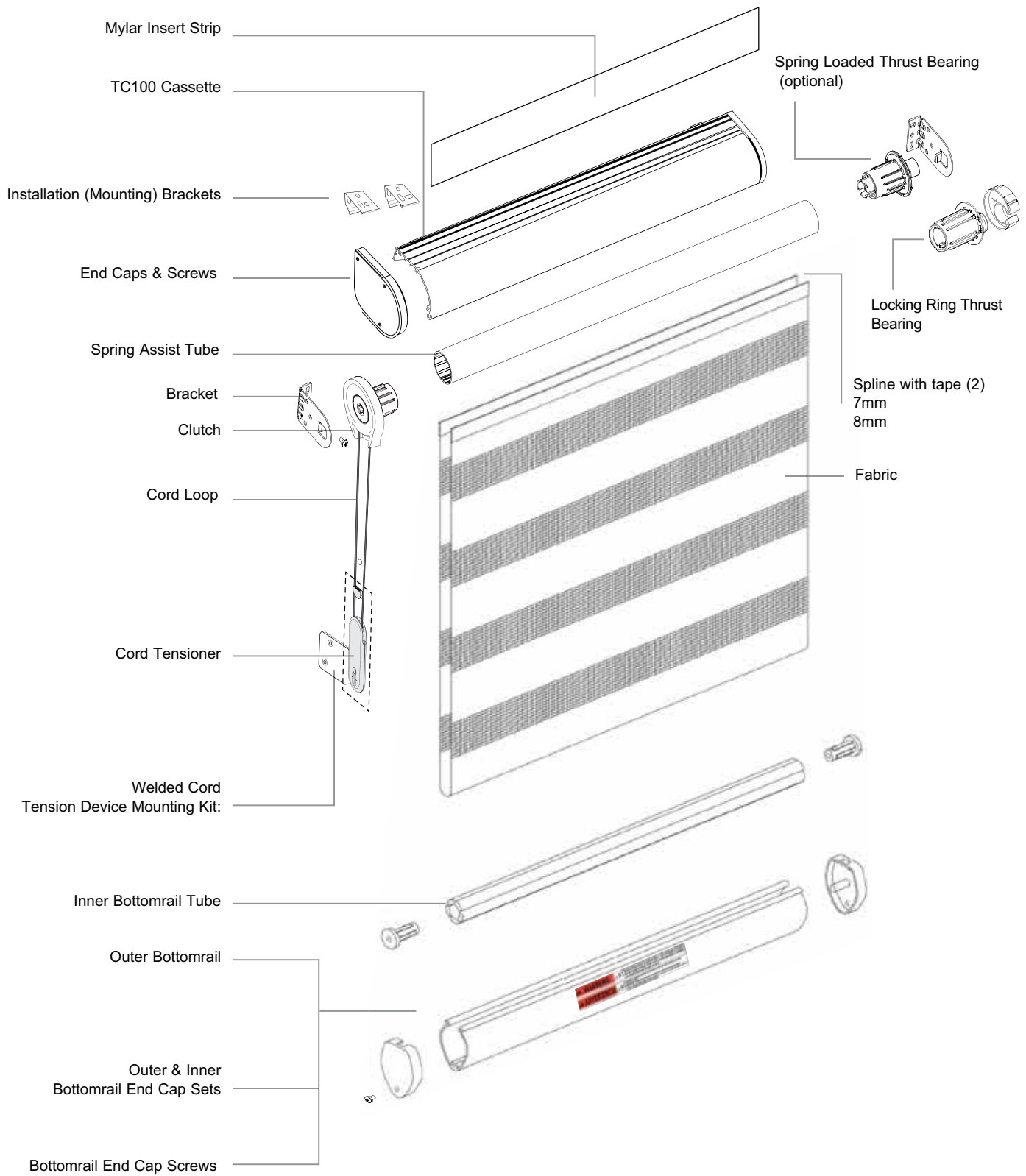

Overtones™ Sheer Shades Hardware Options

POWERTOCH RECHARGEABLE | DESIGNER CASSETTE HEAD RAIL

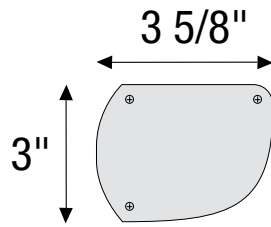
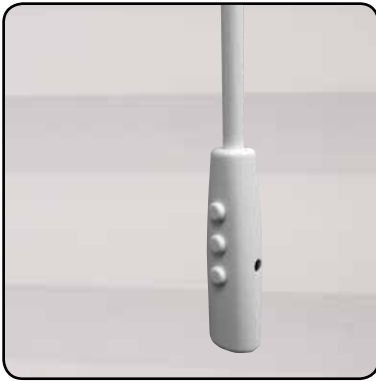

Cord Loop Rail Dimensions

- Depth of cassette: 3⁵/₈"
- Height of cassette: 3"

Hardware Features

Hardware colors for all Overtones fabrics	Integrated cassette head rail and bottom rail will be pre-coordinated to the fabric selection. Matching fabric insert is standard. Fabric wrapped bottom rail is standard.
Wand & Pendant	White

Mounting Dimensions

Mounting Dimensions	Simplicity Motorized Hardware System
Minimum Depth Inside Mount (shallow mount)	1 1/2"
Minimum Depth Flush Inside Mount including brackets	3 3/4"
Minimum Surface Outside Mount	1 1/2"

Finished Dimensions

Inside Mount

	<ul style="list-style-type: none"> • Fabric will measure ordered width less: 1 1/4" • Fabric will measure ordered length • Head rail* will measure ordered width less: 1/4"* • Tube will measure ordered width less: 1 1/8" • Bottom rail outer width will measure ordered width less: 1 3/16" • Bottom rail inner width will measure ordered width less: 1 3/8"
--	--

Outside Mount

	<ul style="list-style-type: none"> • Fabric will measure ordered width less: 1" • Fabric will measure ordered length • Head rail will measure ordered width • Tube will measure ordered width less: 7/8" • Bottom rail outer width will measure ordered width less: 1 5/16" • Bottom rail inner width will measure ordered width less: 1 1/8"
--	---

* Head rail measurements includes plastic endcaps.
Length Considerations: Comfortex will fabricate your Overtones Sheer Shades to the exact length ordered, plus or minus 1/8". The vanes will be in the closed position when the shade is at its full ordered length as seen in Figure B on page 16.

Overtones™ Sheer Shades

POWERTOUCH RECHARGEABLE | DESIGNER CASSETTE HEAD RAIL

PowerTouch™ Rechargeable Shades

Sheer Shadings can be fabricated with the PowerTouch Rechargeable Push Button Control option. The PowerTouch Rechargeable option is an easy, cord free motorized operation for the budget savvy homeowner. PowerTouch Rechargeable uses Simplicity motors and components.

PowerTouch Rechargeable Shades Operation

Press the up or down button on the pendant to raise or lower the shading to your desired position.

No programming is required with PowerTouch™, all programming is set at the factory. Upper and lower limits easily can be adjusted in the field if desired. Favorites position can be programmed on-site. Please refer to the installation instructions at comfortex.com/comfortex-dealers.

PowerTouch Rechargeable Surcharges

See page 8.

PowerTouch Appearance

- The PowerTouch Rechargeable wand and pendant is attached to the head rail and requires no additional mounting.
- The wand and pendant hangs down the front of the shades from the head rail. The wand does not touch the fabric.
- Pendant is 2½" long.



PowerTouch Rechargeable Color Options

- Shadings with Black or Oil Rubbed Bronze hardware will be built with black wand and pendants standard. All other colors will use white wand and pendants.



White



Black Shown with Plug-In Charger

PowerTouch Wand and Pendant Location

The standard location for the wand and pendant is on the right. Please specify location when ordering.

PowerTouch Rechargeable Wand Length

Size and color must be specified when ordered. Below is a recommended size chart.

Shading Length	Standard Wand Length
Up to 30"	1' (12")
>30" to 52"	2' (24")
>52" to 78"	3' (36")
>78" to 100"	4' (48")
>100" to 120"	5' (60")

- Wand length is in 1 foot increments. 1 foot - 5 foot

Mounting Requirements for PowerTouch Rechargeable Shadings

- No special installation hardware or wiring requirements are needed.
- The wand and pendant do not need to be mounted to operate the shading.

PowerTouch Rechargeable Battery Life

The battery life will vary based on the type of window covering selected, the size and weight of the window covering and the number of times you operate the blind on a daily basis.

Battery Charger

8.4 Volt charger requires a standard power outlet to recharge the battery. Must specify charger when ordering a Simplicity PowerTouch Rechargeable Shading. The charger plugs into the charger port. The charger is black and comes with a 156" wire. The dimensions are 1" wide x 2½" length x 1¾" deep.



PowerTouch Rechargeable Shadings Warranty

Please see page 95 for complete warranty information.

Overtones™ Sheer Shades Hardware Options

SIMPLICITY INTEGRATED RECHARGEABLE MOTORIZATION

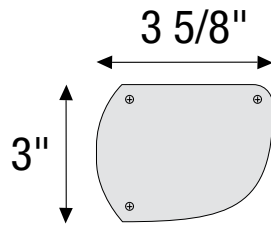

Cord Loop Rail Dimensions

- Depth of cassette: 3 5/8"
- Height of cassette: 3"

Hardware Features

Hardware colors for all Overtones fabrics	Integrated cassette head rail and bottom rail will be pre-coordinated to the fabric selection. Matching fabric insert is standard. Fabric wrapped bottom rail is standard.
Wand & Pendant	White

Mounting Dimensions

Mounting Dimensions	Rechargeable Simplicity Motorization Hardware System
Minimum Depth Inside Mount (shallow mount)	1 1/2"
Minimum Depth Flush Inside Mount including brackets	3 3/4"
Minimum Surface Outside Mount	1 1/2"

Finished Dimensions

Inside Mount

	<ul style="list-style-type: none"> • Fabric will measure ordered width less: 1 1/4" • Fabric will measure ordered length • Head rail* will measure ordered width less: 1/4"* • Tube will measure ordered width less: 1 1/8" • Bottom rail outer width will measure ordered width less: 1 3/16" • Bottom rail inner width will measure ordered width less: 1 3/8"
--	--

Outside Mount

	<ul style="list-style-type: none"> • Fabric will measure ordered width less: 1" • Fabric will measure ordered length • Head rail will measure ordered width • Tube will measure ordered width less: 7/8" • Bottom rail outer width will measure ordered width less: 1 5/16" • Bottom rail inner width will measure ordered width less: 1 1/8"
--	---

* Head rail measurements includes plastic endcaps.
Length Considerations: Comfortex will fabricate your Overtones Sheer Shades to the exact length ordered, plus or minus 1/8". The vanes will be in the closed position when the shade is at its full ordered length as seen in Figure B on page 16.

Overtones™ Sheer Shades

SIMPLICITY INTEGRATED RECHARGEABLE MOTORIZATION HEAD RAIL

Simplicity Rechargeable Motors

The Rechargeable Simplicity Motor program features an integrated rechargeable lithium ion battery in the motor casing and is fully concealed by the roller tube.

PowerTouch Integrated Rechargeable Surcharges

See page 82 for shading standards and page 8 for surcharges and pricing example.

Simplicity Rechargeable Motors

No special installation hardware or wiring requirements are needed to install motorized Shangri-La Shadings with Designer Cassette Head Rail. No external battery wand is required. See page 90 for mounting information.

Rechargeable Simplicity Motor Batteries

The battery for the integrated rechargeable simplicity motor system is integrated within the motor casing and is fully concealed by the roller tube.

Rechargeable battery comes fully charged from the factory.

Integrated Rechargeable Motor Battery Life

Rechargeable battery is included with the motor.

The average battery charge will last 6-12 months based on an average sized shade raised and lowered once per day. The life of the battery charge will vary based on the type of window covering selected, the size and weight of the window covering and the number of times the shade is operated on a daily basis.

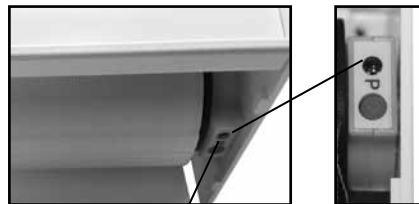

Charging Port

Close-Up

The battery can be recharged up to 500 times. It takes approximately 5 hours to recharge the motor when fully depleted.

Integrated Rechargeable Motor Battery Charger

An 8.4 Volt charger requires a standard power outlet to recharge the battery. The charger must be specified when ordering an Integrated Rechargeable Simplicity Motorized shade. The charger plugs into the charging port of the motor. Required with Integrated Shading order. Sold separately.



The charger is black and comes with a 156" wire. The dimensions are 1" wide x 2½" length x 1¾" deep.

Simplicity Motor Hand Held Remotes

IMPORTANT: Simplicity Rechargeable Motorized Shadings are programmed at the factory with the "up and down" limits. The shades are **UNLINKED** from the remote so they are not able to operate during shipping. Each shade should be installed **before** linking it to the remote.

5 Channel Remote

The **5 Channel (5C) remote** can operate up to five shadings simultaneously, individually or in groups.

Simplicity (5C) remotes and holders are black in color. The remote comes with a holder which can be mounted to a wall for easy storage. The range of the remote is approximately 80 feet.



Please Note:

- Not all motors run at the same rate of speed.
- Simplicity motors have a "Favorites" or "MY" position setting. If the homeowner wants to set several shadings at the same intermediate position, follow instructions provided with installation manual.
- **WHEN ORDERING THE NEW INTEGRATED RECHARGEABLE, PLEASE ORDER THE NECESSARY BATTERY CHARGER.**

Overtone™ Sheer Shades SIMPLICITY INTEGRATED RECHARGEABLE MOTORIZATION

Important Information about Integrated Rechargeable Simplicity Motor Shading Operation and Installation

- Simplicity Motorized Shades installed into windows with metal casings may have a reduced radio frequency range, or may not operate at all, depending on control.
- Be mindful of when your shade starts to slow down during operation. It is a good indicator the shade needs to be recharged.

Simplicity Battery Operated Motorized Shadings Warranty

Please see page 95 for complete Comfortex warranty information.



Paradise & Overtones

MEASURING INSTRUCTIONS

Important Measuring Guidelines

Comfortex accepts measurements down to 1/16" increments.

Precise width and length measurements are critical. Fabric width cannot be altered after the shading is fabricated.

Please use a metal tape measure for accuracy.

The head rail must be installed perfectly level and installed evenly to ensure smooth operation. On an inside mount, it is recommended that you check to see that the mounting surface is level and consistent. If your soffit needs to be leveled, this should be done before measuring.

Inside Mount

Measure across the width of your window opening in three different places - top, middle and bottom. Measurements should be taken within the window jamb. Provide the smallest of the three measurements to Comfortex. Be exact. Comfortex will make the necessary deductions to fit the window opening. Measure the length of the window opening from the underside of the soffit to the surface of the window sill in two places - use the smallest of these two measurements.

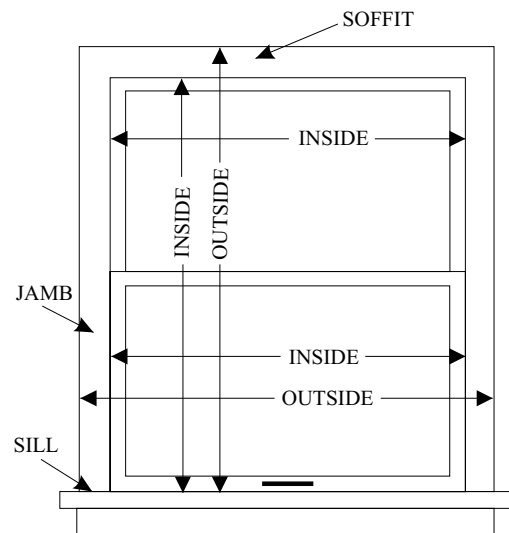

Outside or Ceiling Mount

Measure the exact width and length of the area to be covered. On the width, allow at least 1 1/2" of an overlap on each side. An overlap of 3" on each side is recommended. Be sure to take into consideration any obstructions such as window trim, molding, locks and window cranks.

Child Safety

All Comfortex products have been fully tested and proven to comply with the current WCMA Standards for safety of corded window coverings.

Be aware that it is possible for children to become entangled in window covering cords. To reduce the risk of accidents, all cords must be kept out of the reach of children.

Cord Tensioners

Cord tensioners used on Shangri-La and Soft Tones Shadings continuous cord loops keep the continuous cord loops taut to prevent children and pets from becoming entangled and subsequently injuring themselves. Cord tensioners must be used with Shangri-La and Soft Tones Shadings to comply with the Consumer Product Safety Commission (CPSC) Child Safety Guidelines.

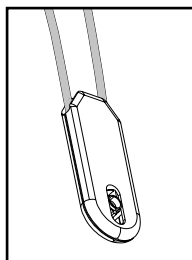

Cord Tensioner

Shangri-La Shadings with Retractable Cord Hardware

Retractable Cord hardware is safe alternative to conventional cord loop controls by retracting and limiting the cord length.

Vertical Sheer Shadings

The combination wand/cord option integrates both tilt and traverse functions into one easy-to-use control that keeps the cord taut. The moving wand option used on Vertical Sheer Shadings allows all functions to be controlled by a single wand without the need for operating cords.

! WARNING



The cords on this product present a potential strangulation hazard.



For child safety, consider cordless alternatives or products with inaccessible cords.

! ADVERTENCIA



Los cordones de este producto representan un peligro potencial de estrangulamiento.



Para la seguridad de los niños, utilice alternativas sin cordón o productos cuyos cordones sean inaccesibles.

! MISE EN GARDE



Les câbles de ce produit représentent un danger potentiel de strangulation.



Pour la sécurité des enfants, pensez au sans fil, ou procurez-vous des produits dont les câbles ne sont pas accessibles.

Conditions of Sale

All Comfortex products are custom fabricated to your exact specifications. We cannot accept responsibility for errors in ordering or cancellations and charges after the order is in production.

Policies

Our policies are designed to provide a guide for doing business with Comfortex. Our first priority and number one policy is to provide the highest level of service and total satisfaction.

Freight

Comfortex will ship all orders for fabricated shades or blinds freight free via UPS, FedEx Ground or other similar method within the continental United States*.

A \$3.75 per unit transportation surcharge will be added to all fabricated product orders, within the continental United States, including shades/blinds, vane packs, individual vanes, tracks, valance and cut yardage orders.

In addition, a \$70.00 Common Carrier surcharge** will be added for all orders shipped within the continental United States*, that include shades, blinds or valances with widths of 98" or more and are required to ship by motor freight. Exception: Verticals with lengths of 84" or more, and Roman Shades with widths of 94" or more are required to ship by motor freight.

***Hawaii:** Shipments to Hawaii will incur a freight charge of \$50.00 per unit when shipped from within the Continental US.
****In Addition,** a \$110.00 Common Carrier surcharge for oversized shipments will be added to orders shipping to Hawaii.

***Alaska:** Shipments to Alaska will incur an \$8.00 per unit transportation surcharge when shipped from within the Continental US.
****In addition,** a \$110 Common Carrier surcharge for oversized shipments will be added to orders shipping to Alaska from within the Continental US.

Canada: Shipments to Canadian Dealers will incur a \$6.00 per unit transportation surcharge when shipped from within the Continental US. In addition, a \$110 Common Carrier surcharge for oversized shipments will be added to orders shipping to Canada from within the Continental US.

Comfortex Mexico Plant: All shipments from our Mexico plant to Alaska, Hawaii or anywhere outside the Continental U.S. will incur all freight charges (freight forwarder needed if shipping to another country).

Freight continued

All Other Countries: All United States dealers requesting to ship orders outside the United States must provide a freight forwarder for Comfortex to ship to within the continental United States. Comfortex cannot ship directly to your customers located outside the United States.

Please Note: Comfortex reserves the right to select another carrier, modify shipping terms or change freight policies without notice.

Service and Repair

Service may be obtained by contacting our Customer Service Department. No products, parts, components or other materials will be authorized for return or repair without prior approval from Comfortex. A Return Authorization (RA) may be obtained by contacting our Technical Service Department. In order to provide the quickest service possible, please have your Comfortex Sales Order number and original order information available when you call.

Charged Marketing Materials

All charged marketing materials will incur freight charges. Marketing materials may ship on separate days, from different locations. Freight charges are calculated per package, not per order.

Specifications

All Comfortex products are designed and tested to perform as intended within established, published parameters. Requests for "custom fabrication" of products outside of our published specifications may be considered, but are at the discretion of the Comfortex Technical Services department. Restrictions and additional charges apply.

Download installation instructions, order forms or additional price list copies at www.comfortex.com/comfortex-dealers. The files can be found in the Dealers Resource Center or on the OnDemand Mobile Library.

Motorized Shadings Warranty

Simplicity Motors including PowerTouch Shadings and Integrated Rechargeable Motorization

We offer a 5 year warranty on all motors and controls. Specifically, we warrant the Simplicity motors and controls to be free from defects in material and workmanship under normal and proper use for a period of 5 years commencing with the date stamped on each product. If the Simplicity product fails within this 5 year period, we will repair or replace it free of charge through your end product supplier. Batteries are not covered by the warranty.

Sheer Horizontal & Vertical Shadings Warranty Information

Knitted fabric may experience minor weave variations due to heat, humidity and other room conditions. These variations can result in light bowing, puckering and dimpling of the Shangri-La material. This is considered normal and does not constitute a failure in either workmanship or materials. The possible variations are minor and have been shown through case study not to detract from the beauty of the product.

Warranty Information Regarding the Braided Cord on Shangri-La Sheer Shadings and Soft Tones Shadings with Designer Cassette Hardware:

Designer Cassette Shadings built with a braided cord do not have a reverse roll stop. If a Shangri-La or Soft Tones Shading with the Designer Cassette Head Rail is raised above 24" in the reverse roll mode, there is a possibility of the fabric rubbing on the head rail. Comfortex reserves the right NOT to warrant wear and tear of fabric if damaged by roll-up in excess of 24".

Shangri-La, Soft Tones, Vertical Sheer Shadings, Paradise Sheer Shadings and Overtones Limited Lifetime Warranty

Comfortex warrants that its window treatments will be free from defects in materials and workmanship for as long as the original residential purchaser owns the product, provided that the product was installed properly and in accordance with the installation instructions. The Limited Lifetime Warranty is extended to the original residential purchaser only, in the original window for which it was installed.

The Warranty does not include any conditions or damages resulting from accidents, alterations, misuse, abuse, misapplication, improper handling, installation, repairs, operation, cleaning, exposure to any and all natural and manufactured excessive heat sources. (Excessive heat sources include, but not limited to; magnification of sun light through cubes of glass, heaters of any kind, ovens, candles, lighting fixtures, etc.) This warranty does not cover variation in fabric color, grain, or texture in natural wood products nor excessive warping of wood slats in high humidity areas. Loss of pleating is not covered if the product is not being cycled (held in the raised position a portion of the time). Normal wear and tear is not covered.

All moving parts, such as cords and strings (internal and external), will eventually wear out and fabric may fray. Comfortex considers these things as normal wear and tear and will carry a three year Limited Warranty. All fabric, including fabric vanes, panels, inserts, and shades carry a five year Warranty. Fabric cell separation is covered for a lifetime. See Comfortex Standard Return and Repair Policy for more details.

This Limited Warranty does not cover transportation costs to and from the retailer, costs of removal, re-measure, reinstallation of product, or any incidental or consequential damages.

If a Comfortex product is found to be defective in materials or workmanship, we will, at our discretion, repair, replace or refund the cost of a product which fails to conform to this Limited Warranty. Colors vary from lot to lot and may not exactly match sample swatch, sample book, or previous purchases. Discontinued components or color selections will be replaced with the closest equivalent current product. This shall be your sole remedy under this Limited Warranty.

To obtain service, contact the Dealer from whom you purchased the product.

This Warranty is exclusive and in lieu of all other obligations, liabilities or warranties. In no event shall Comfortex or its licensed fabricators or distributors be liable for incidental or consequential damages, or for any other damage, loss or expense, cost or fee associated with such damage. In some states, exclusions for incidental or consequential damages are not allowable. Comfortex Dealers and Fabricators must use safety devices supplied by Comfortex in accordance with Window Covering Safety Counsel guidelines.

This Warranty gives you specific legal rights, and you may also have other rights, which vary from state to state. Policy is subject to change without notice.

This Limited Warranty is exclusive of commercial use. Contact Comfortex Technical Service for more information. No agent, representative, dealer or unauthorized employee has the authority to increase or alter the obligation of this Warranty.

This Limited Warranty supersedes any previous versions.

©2018 COMFORTEX CORPORATION

TM is a trademark of Comfortex Corporation. ® is a registered trademark of Comfortex Corporation. Shangri-La® are registered trademarks of Comfortex Corporation. PowerTouchTM and Omni-ViewTM are trademarks of Comfortex Corporation. Energizer® is a registered trademark of Energizer Holdings, Inc. Swiffer® is a registered trademark of Procter & Gamble. Pledge Grab-It is a registered trademark of S. C. Johnson & Son, Inc. U.S. and foreign patents pending. The GREENGUARD INDOOR AIR QUALITY CERTIFIED Mark is a registered certification mark used under license through the GREENGUARD Environmental Institute. All rights reserved under license by Comfortex Window Fashions. U.S. and foreign patents pending. All rights reserved.



Vertical Sheer Shadings



Paradise™ Sheer Shadings



Overtones™ Sheer Shades

What's Inside:

- PowerTouch™ Rechargeable Motorization for Shangri-La® and Soft Tones
- Simplicity Rechargeable Integrated Battery for Shangri-La® and Soft Tones
- Shangri-La® Sheer Horizontal Shadings
- Vertical Sheer Shadings
- Soft Tones Sheer Shadings
- Certified Best For Kids Products
- Overtones™ Sheer Shades
- Paradise™ Sheer Shadings



www.midwestdesignersupply.com

888-523-2611
262-524-1007 (fax)

